

OUR PRODUCT RANGE
DECK- & GARDEN

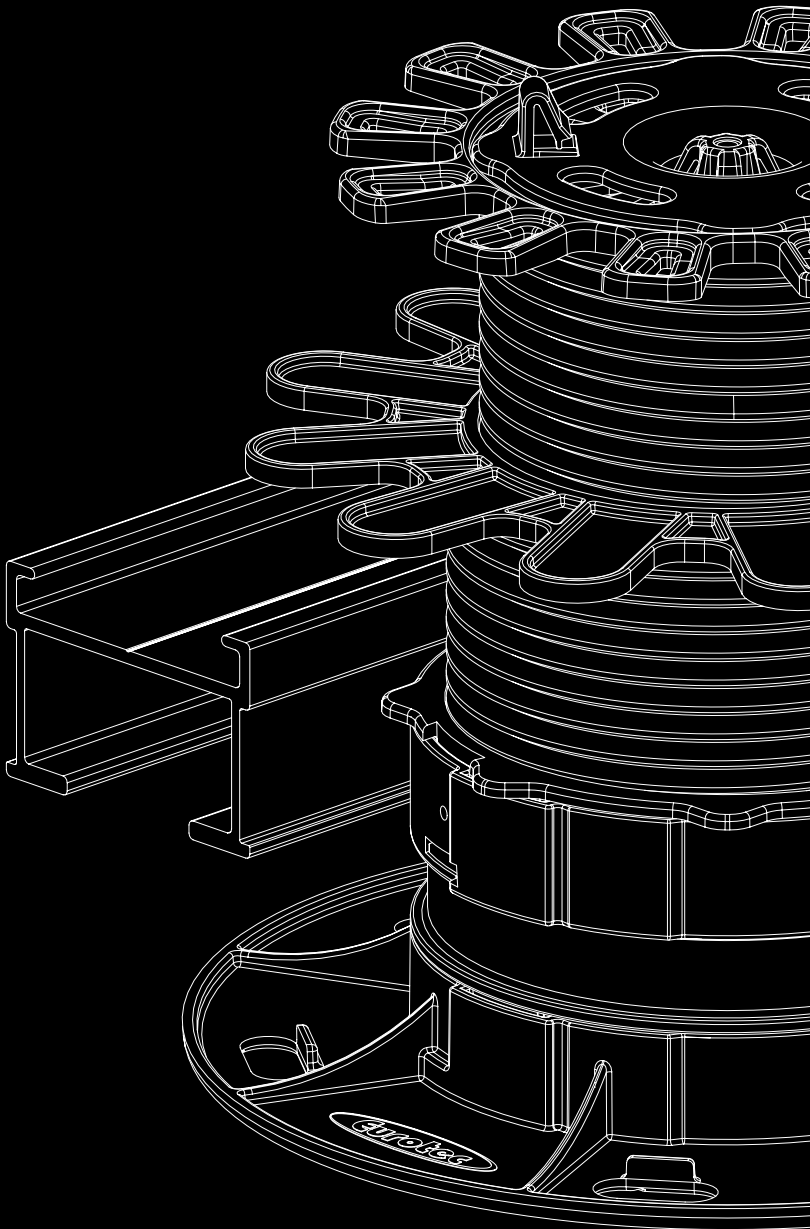

ADJUSTABLE PEDESTALS

ALUMINIUM PROFILES

EDGE JOINTS

**VISIBLE / HIDDEN
FASTENING ACCESSORIES**

**SCREWS FOR TERRACE
CONSTRUCTION**

**WOOD CONNECTORS
AND FITTINGS**



INDEX

ABOUT EUROTEC	6-9
OUR EXPERTISE ESPECIALLY FOR YOU: WHAT ASPECTS ARE IMPORTANT WHEN BUILDING TERRACES?	10-19
ACCESSORIES FOR DECKING SUBSTRUCTURES	20-25
ADJUSTABLE PEDESTALS AND ACCESSORIES	26-57
ALUMINIUM SUBSTRUCTURES	58-111
TERRACE EDGING	112-127
HIDDEN FASTENING ACCESSORIES	128-139
VISIBLE FASTENING ACCESSORIES	140-171
ACCESSORIES FOR WOODEN FAÇADES	172-179
WOOD CONNECTORS AND FITTINGS	180-191
INDEX	194-195

DISCOVER INNOVATIVE FASTENING TECHNOLOGIES ON OUR INSTAGRAM CHANNEL

On our @eurotec_gmbh channel, you will find practical professional tips that will help you add long-term value to your projects.

Feel inspired by our customers' construction projects, gain exclusive insights into our production and discover the latest product highlights.

Experience first-hand how we take technology and quality to a new level!

**FOLLOW
US NOW:**



#BUILDWITHEUROTEC

EXPLORE NOW!





ABOUT EUROTEC

We are a medium-sized company engaged in the development, production and sale of products for the construction sector. To this end, we supply products for the areas of timber-frame construction, deck construction and concrete fastening. We supply specialist dealers across Europe, who are responsible for distribution to skilled craftsmen.

Over 25 years, Eurotec has established itself as a consistent leader in the fastening technology segment. Since January 2013, a carefully selected part of the timber construction screw range has been manufactured in Hagen. By expanding our machine park, we have extended our production capacity, so that a wide range of our products can now be produced in-house.

TERRACE SYSTEMS FROM THE SPECIALIST

In addition to innovative products for timber construction, roof and facade or concrete and masonry, the company's product portfolio covers a wide range of high-quality items for terrace products of all types. From sturdy adjustable feet to robust system profiles and fastening elements – for visible or concealed decking board fastening – and even matching accessory parts, we have everything you need to achieve your individual construction project.

BUILDING DECK HAS NEVER BEEN SO EASY!



VARIETY MADE IN-HOUSE

With the start of production in our in-house production facility in 2013, we took an important step in our company history in order to establish ourselves on the market with our product range. To satisfy the high quality demands of our customers and ensure that they are implemented consistently, producing in-house is a major advantage. It makes it easier to provide short delivery times and rapid response times.

The in-house plastic division can produce complex, small-part and multi-part plastic parts especially for terrace and garden construction. Cutting-edge machinery including high-performance injection moulding machines makes it possible to process a wide range of thermoplastics. The production range of multi-dimensional plastic injection moulding parts includes our adjustable feet and various adapters.

WORKING SUSTAINABLY

As a company, we appreciate the importance of environmental awareness and sustainability: 100 % of our rejects and defective parts are recycled and then ground into smaller granules (regrind) to be fed back into the processing chain. In production, we are especially committed to using natural resources and minimising our environmental impact in the various divisions.

Moreover, this also entails a reduced carbon footprint, the promotion of renewable energies, compliance with ethical supply chain standards and a commitment to social responsibility. A holistic sustainability strategy can help ensure long-term success and make a positive contribution to both society and the environment.



CONSTRUCTION SITE – WE CAN HELP WITH EXPERT ADVICE

Service from a single source: You can trust in us even during the terrace preplanning phase. We can support you in choosing the right product and planning your project. We can also provide advice on exclusive options. During the construction process, our experienced sales reps support our customers on site, offering customer-focused on-site assistance from A to Z. This means that ideas can be developed and discussed right at the project site. The planning of large-scale projects is also supported and coordinated by our sellers from the outset.

INTRODUCING: OUR TICKET SYSTEM

With our ticket system, you can submit enquiries quickly and easily and track the status of your requests at any time. Every enquiry is assigned a unique ticket number, so you and our support team can always keep track of everything. In this way, we ensure that your requests are efficiently processed and quickly resolved.

- Simple & structured – Submit your requests in a straightforward manner.
- Transparent – View both the current status and our replies at any time.
- Efficient – Quick processing by our support team.

Do you have any questions?
Create a ticket now so we can help you!



SERVICE IS ONE OF OUR TOP PRIORITIES

To ensure that all requirements continue to be fulfilled, we keep the issue of sales in mind at all times and offer our customers an extensive range of services.

We aim to share our specialist expertise and many years of practical experience with you. We can offer you and your customers both online and in-house seminars and can also provide in-person training on the construction site.

Do you have any other unanswered questions?

Whether it's in person, by phone or by email – we are always happy to provide in-depth one-to-one advice and offer help



WE CAN ALSO TRAIN
YOUR EMPLOYEES.
GET IN TOUCH!



WHAT ASPECTS ARE IMPORTANT WHEN BUILDING TERRACES?

1

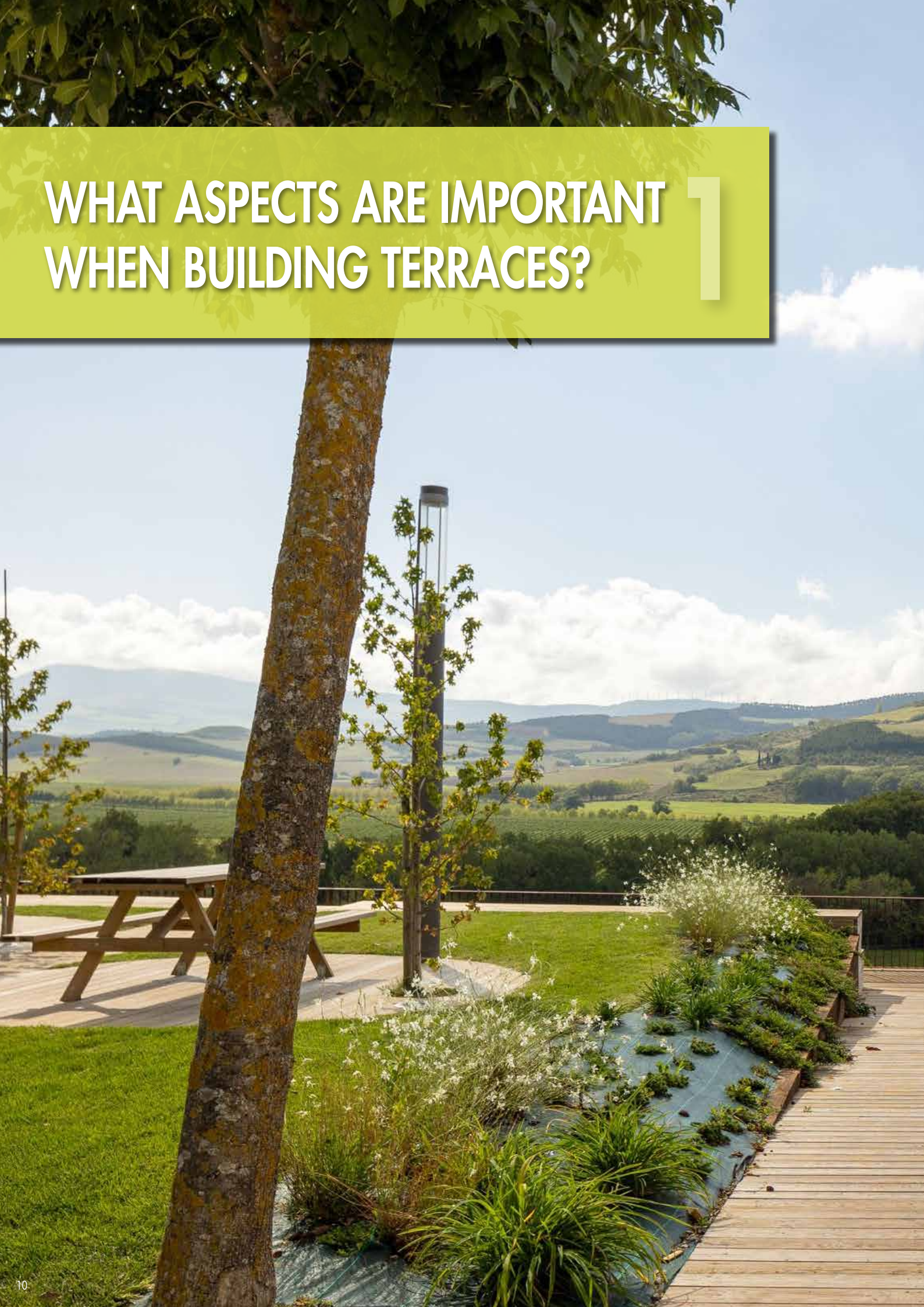



PROCESSING INSTRUCTIONS TERRACE

Substructure

A properly executed substructure is of great importance for a stable and durable wooden terrace. On the one hand, it has the task of supporting the actual decking, so that a flat surface is maintained even under a heavy load. On the other hand, it serves as the constructive protection of wood by creating a distance between the ground and decking/wooden supports. The wood is thus neither exposed to waterlogging or increased wood moisture in the ground-air zone. Waterlogging and increased moisture content coupled with the use of unsuitable wood species would create a breeding ground for wooddestroying organisms.

In the following, we would like to show you various approaches to the construction of a terrace substructure.

A supporting ground is required. This can be compacted soil or gravel as mentioned before. This is where the foundation rests on. The support timbers are laid on these.

The foundations create the above mentioned necessary distance between soil and wood and remove the emerging loads.

Here are three examples for the installation of substructures:

1 Paving slabs

Paving slabs on the base layer provide a stable foundation. With the EPDM Rolfi spacer and the Rolfi roll, wood preservation is provided by design. Paving slabs are, however, hard to level and align.

2 Concrete foundation slabs

Concrete foundation slabs are an alternative to the paving slabs and are generally designed for two different timber board cross sections. It can still be difficult to adjust the height, however

3 Adjustable pedestals by Eurotec

The adjustable pedestals can be placed directly on compacted ground or on concrete. The time-consuming construction of the foundations and the relining of the substructure wood for height adjustment are eliminated. The height can be infinitely adjusted together with the supporting joint, which is connected by a bracket directly to the adjustable foot.



HAZARDS IN THE CONSTRUCTION OF TIMBER DECKS

The various timber types differ from one another not only in their appearance but also in their technical properties:

- One particularly important property of wood with regard to deck construction is **dimensional stability** (also known as “resilience”). Experts use this term to refer to the property whereby wood changes shape in the course of use due to swelling or shrinkage. The various timber types show different degrees of dimensional stability. For this reason, special attention must be paid to the choice of the timber type. For deck construction, we recommend using timber with high dimensional stability. Some timber types, including **Massaranduba**, exhibit lower-than-average dimensional stability, so we explicitly advise against using these timber types for deck construction. Since, from an absolute perspective, the swelling and shrinkage behaviour increases as the width of the timber boards increases, we also recommend a maximum board width of 120 mm. You can find details of the dimensional stability of some common timber types in the “Overview of timber types” on p. 22 – 27 of our catalogue.
- **Rift-sawn** planks should always be used in preference to flat-sawn planks, as they have considerably better properties with respect to cracking, splintering, swelling and shrinkage, as well as dimensional stability, and therefore tend to distort and warp less. Often, so-called flat-sawn planks cannot be fastened permanently with either visible or hidden methods. In such cases, we cannot guarantee permanent fastening.
- Even fine particles of abraded metal can lead to dark spots of corrosion on the timber boards. Metalwork should not therefore be carried out in the direct proximity of the deck.
- Constituent substances in the timber can cause contamination of adjacent surfaces; it is therefore important to take **constructive precautions**, such as maintaining sufficient distances from nearby components.
- As nature does not adhere to quality guidelines, the suitability of timber for deck construction does not depend solely on the timber type. Often, problems can occur even due to individual batches of a timber type that is normally harmless. Possible reasons for this include **spiral grain and insufficient drying**.
 - Spiral grain refers to a wood grain that has grown in a spiral around the trunk axis; this becomes a problem if, in the course of use, the moisture contained in the wood deviates from the moisture level at installation. If this happens, internal tension in the wood is released and can therefore cause the deck boards to warp. The energy released in this process is so enormous that it often impairs even perfectly installed fastening systems.
 - It is a property of every timber to be able to absorb and emit water. For the user, this property can primarily be perceived through the timber’s swelling and shrinking. One task of the timber trade is to bring timber to the correct state of dryness for the respective area of use. If timber is used that has an incorrect moisture content at installation, this can quickly lead to damage.
- Many properties of the timber vary strongly depending on the grade. **It is therefore advisable to contractually stipulate all criteria in advance with your timber dealer!**
- Particular care should be taken when purchasing Bangkirai. In the past, increased demand often meant that substitute timber from South East Asia was – knowingly or unknowingly – traded as Bangkirai. Most of these substitute timbers are considerably less suitable for deck construction. This results in cracking, strong warping and bending of the boards.
- It is essential to use identical timber types in order to ensure the durability of the deck – i.e. the upper deck and substructure must be made of the same material.
- **Application of bits made of stainless steel**
When setting screws, it inevitably always leads to a little abrasion between the screw drive and bit. This abrasion can lead to discolouration of the wood surface and the screw head in outdoor applications or in wet rooms, when attaching wood rich in tannins. Mistakenly, this is often attributed to the screw, even if it is made of stainless steel. In order to avoid the risk of discolouration due to extraneous rust, stainless steel bits should also be used for setting stainless steel screws!

A lot of damage to deck structures can be prevented in advance by thoroughly inspecting the timber that is to be installed. If, for example, the tradesman responsible already notices deformation in the deck boards before installation, none of these boards should be installed.



TIMBER

Wooden terraces are a versatile and appealing option for many different environments. Whether you choose natural wood, which turns grey over time, or treated timbers depends on your personal preferences and the look you are aiming for.

The right fastening system goes hand in hand with good planning and a professional installation to ensure a durable and low-maintenance terrace construction. Different types of timber can differ in their technological characteristics. For this reason, you should consider not only their look and cost but also their durability and suitability for certain fastening methods. For example, a highly durable and aesthetically pleasing timber may not necessarily have the best characteristics in terms of sturdiness or fastening options, which highlights the need for careful consideration of these different aspects when selecting the timber for your terrace.

An overview of common terrace timbers may help you make the right decision for your needs. In doing so, you should consider factors such as the durability, care requirements, appearance as well as costs.

SELECTING SCREW STEELS BASED ON THEIR CORROSION RESISTANCE

Step by step

Select the right screw material for your project by observing the following principles. Go through the three points one after the other. The right material is marked for points 1 and 2 with (✓) at least, or even better with ✓. In the event of additional chemical stress, point 3 must conform as well.

- 1 What's the component's situation? Is it exposed to the weather (fence) or is it protected (ceiling beam)?
- 2 Which wood is being fastened? Is it simple construction wood, or tannin-rich tropical wood?
- 3 Are there any additional stresses in situ that encourage corrosion? Location near the sea? Heavy industry, etc.?

Example: fastening a façade made of Douglas fir

1. Use class = 3, because exposed to weather. Façade = optical requirements. → at least C1
 2. Douglasie → at least C1, but an A2 or A4 is to be preferred.
 3. This point is not required, because there are no further external stresses.
- Selection: C1 is possible, but A2 or A4 is to be preferred.

The following overview cannot cover all applications. In individual cases, materials can also be assigned to less favourable ambient conditions.

Steel group	Carbon steel		Stainless steel, martensite	Stainless steel, austenite	
	Electroplated	Special coating	C1; hardened stainless steel	Stainless steel A2	Stainless steel A4
Product examples	Panelwistec blue / yellow Hobotec blue / yellow	Panelwistec 1000	Terrassotec stainless steel, hardened Hapatec	Terrassotec A2	Terrassotec A4 Hapatec Heli
1. Position of the component?					
Service classes 1 ^{a)}	✓	✓	✓	✓	✓
Service classes 2 ^{a)}	✓	✓	✓	✓	✓
Service classes 3 ^{a)}	-	(✓) ^{b)}	✓	✓	✓
2. Which wood? ^{c)}					
Structural timber, wood materials ^{d)}	✓	✓	✓	✓	✓
Beech (red beech)	✓	✓	✓	✓	✓
Douglas fir	-	-	(✓) ^{e)}	✓	✓
Spruce	✓	✓	✓	✓	✓
Pine	✓	✓	✓	✓	✓
Larch	-	-	(✓) ^{e)}	✓	✓
Coniferous wood, pressure-impregnated	(✓) ^{b)}	(✓) ^{b)}	(✓) ^{b)}	(✓) ^{b)}	✓
Red cedar	-	-	-	(✓) ^{f)}	✓
Fir	✓	✓	✓	✓	✓
Thermotreated wood from coniferous wood	-	-	-	(✓) ^{f)}	✓
Abachi	-	-	-	(✓) ^{f)}	✓
Afzelia, doussié	-	-	-	(✓) ^{f)}	✓
Azobé, bongossi	-	-	-	-	✓
Bangkirai, balau	-	-	(✓) ^{e)}	✓	✓
Bilinga	-	-	-	(✓) ^{f)}	✓
Courbaril, jatobá	-	-	-	-	✓
Cumarú	-	-	-	(✓) ^{f)}	✓
Sweet chestnut	-	-	-	-	✓
Oak	-	-	-	-	✓
Eucalyptus	-	-	-	-	✓
Garapa	-	-	-	-	✓
Ipé	-	-	(✓) ^{e)}	✓	✓
Iroko	-	-	(✓) ^{e)}	✓	✓
Itaúba	-	-	-	-	✓
Kosipo	-	-	-	-	✓
Massaranduba	-	-	-	-	✓
Merbau	-	-	-	-	✓
Robinia	-	-	-	-	✓
Thermally modified timber made from hardwood	-	-	-	(✓) ^{f)}	✓
3. Additional chemical load?					
Constant condensation ^{g)}	-	-	-	(✓) ^{b)}	✓
Salt load ^{h)}	-	-	-	(✓) ^{b)}	✓
Aggressive atmospheres ^{k)}	-	-	-	-	(✓) ^{m)}
Chlorous atmospheres ^{l)}	-	-	-	-	-

a) Use classes in accordance with DIN EN 1995:2008. Service classes 1 - components in structures enclosed on all sides, partly heated.

Service classes 2 - components in roofed, open structures without direct weather exposure. Service classes 3 - freely weathered constructions.

b) Recommended only for less significant fastening points, or for temporary objects, or if there are no visual requirements.

c) Pilot-drilling and, where applicable, pre-countersinking, is recommended in general for hardwoods. This also applies for coniferous woods in deck and façade construction.

d) Untreated: spruce, fir, pine, composite timber, KVH®, veneering laminated wood, solid wood, etc., plywood, OSB, fibreboards, cement-bound and gypsum fibreboards, etc.

e) In our experience, using this timber with C1 does not lead to problems with corrosion or timber discolouration.

Depending on the origin of the timber, however, this cannot be ruled out completely. Please also inquire at your timber dealer.

f) Use of A4 is recommended. Please contact your wood dealer as well.

g) Uninterrupted condensation in a water vapour atmosphere with only slight impurities.

h) Building components close to roads heavily affected by salting in winter, coastal areas, in offshore and other industrial installations.

k) For example: building components in road tunnels, pig stalls or in other aggressive atmospheres, possibly with additional higher air humidity.

l) Building components in indoor swimming pools or other chlorous atmospheres.

m) Use to be checked in the individual case.

This overview cannot take account of all applications. Materials can be assigned to more unfavourable conditions as well in an individual case.

WOOD DECKS

Because of constantly occurring problems with the use of hardwood/tropical woods we want to point out some fundamental working guidelines that must be observed. However, we refer in general to the recommendations of your wood dealer, because there can be extreme fluctuations in the wood properties with the same wood type, above all with tropical woods. Bangkirai wood, for example, which is often used, can have very different properties, because the properties depend heavily on the source in each case. If the variety of wood properties within a range is ignored, this can lead to various problems with regard to screws breaking off.

At a width of 140 mm, Bangkirai woods or other hardwood/tropical woods can swell or shrink by up to 7 mm, depending on the wood moisture. With direct screwing through the boards into the substructure we recommend using a pair of screws. If the board is fastened directly on the substructure and the board works from the centre by about 3,5 mm, this leads in some cases to the screws being sheared off. The hardwood/tropical wood does not allow the screw to absorb any movement because it can barely be compressed because of its own high density.

Although deck/wood construction screws today have a suitable deflection angle, hardwoods that are placed directly on top of each other function as shearing plates that shear the screws off if the wood swells or shrinks. (Per board half = 3,5 mm displacement, this conforms to about the inside diameter of a screw with a 5 mm thread, which is the minimum that should

be used with tropical woods).

In certain circumstances, screwing in the centre of the board might be deducted from this. Unfortunately, tropical woods have an extremely high internal stress, which leads to the boards twisting (dishing), which in most cases requires pairs of screws.

However, **using a spacer** (e. g. distance strip 2.0 or deck glider) between the substructure and deck board is very helpful here. This provides the screws with a possibility of bending in the direction of the working wood. The danger of shearing is greatly reduced. In addition, this clearance protects the wood from waterlogging at the support points. The ageing process is slowed down clearly.

A mistake that is frequently made is to have centre distances in the substructure that are too large. The most durable results are achieved if this clearance, and therefore the screw clearance in the lengthwise direction of the boards, is max. 60 cm.

Please note that the installation information provided here is merely a recommendation and does not constitute binding assembly instructions. Every assembly job is subject to different performance requirements, e. g. locally applicable building regulations, and the tradesman carrying out the installation is responsible for compliance with these requirements.



OUR HINT:
DRILL-STOP
PILOT DRILLING +
COUNTERSINKING

Pilot-drilling is always better with problematic woods. These are above all hardwood/tropical woods, but also some coniferous woods that tend to crack easily, such as e. g. Douglas fir.

Pilot drilling prevents the wood splitting. With regard to the edge distances make sure that there is at least 6 cm clearance to the end of the board.

(Please note: because of the high internal stress the boards can also crack open later at the ends and in the middle. This also applies to thermally treated woods).



DISCOVER NOW: OUR DECK SOFTWARE



INNOVATIVE, USER FRIENDLY AND FULL OF NEW FUNCTIONS

The terrace software to facilitate material requirements planning for terrace construction now, in addition to a general design update, features not only a super user-friendly interface, but also a host of new features. These include, in addition to the industry-standard basics, gradient and discharge planning, sketches as well as detailed product dependencies, so that you always have the best results for your material requirements planning.*

START NOW WITHOUT REGISTERING:

Without registering, you can access all planner features and plan up to 15 m² for free. For further planning options, simply register or contact us at terrasseplanen@eurotec.team.

CLICK HERE
FOR OUR **DECK**
CATALOGUE:



Individual designs with free planning

When selecting your basic shape, you can not only pick from the terrace geometries that are already available. You also have the option to map more complex geometries with the help of free planning.



Heights, gradients and drains

The deck software makes it easy to plan the elevation level of your building project. The elevation data is displayed systematically for each adjustable foot. Even gradients do not pose a problem for terrace planning, thanks to the customisable height points.



Planning result*

Get the best planning result for material requirements planning for your project specifications, including a downloadable PDF and the option to send your project directly as an email.

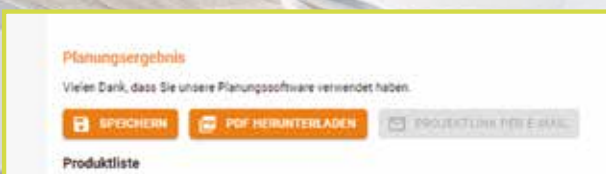

Save the code and continue later!

During the planning process, you can save your project as a link with the save function and continue working on it at a later stage.

* For the calculation, assumptions were made on the basis of the information you provided. Check the assumptions made. The specified values, type and number of fasteners are planning aids as offered. Volumes may deviate during implementation planning

ACCESSORIES FOR DECKING SUBSTRUCTURES

2





CORK ACCESSORIES FOR DECKING SUBSTRUCTURES

CORK, WHAT IS IT?

Cork is a natural product obtained from the bark of the cork oak. The cork oak is a deciduous tree that is native primarily to the western Mediterranean, e. g. Spain and Portugal. To harvest the cork, the bark is peeled directly off the tree by hand. As cork is a renewable natural product, a tree can be reharvested approx. every 10 years without causing damage to the tree. A cork oak has a life expectancy of up to 300 years and delivers approx. 100 to 200 kilograms of cork over its lifespan.

PROPERTIES AND ADVANTAGES

- Water-repellent (hydrophobic) and moisture-resistant
- Chemically neutral – free of PAHs (PAHs are toxic, carcinogenic plasticisers that are found primarily in rubber compounds)
- Does not decompose and is resistant to most acids and lye
- Dampens footfall sound, is non-slip and insulates against heat, noise and vibrations
- Resistant to rot, bacteria and germs
- Very pressure-stable and exhibits hardly any expansion
- Flame-resistant (fire class B2)

CORK IS A SUSTAINABLE, ENVIRONMENTALLY FRIENDLY NATURAL PRODUCT.



The cork pad spacers are laid between the deck substructure and the foundation / subsurface (self-adhesive on one side) and thus form a gap that aids constructive timber protection. The cork pad spacers are available in three sizes. These are 3 mm, 6 mm and 10 mm thickness/height (see Fig.). In addition to the advantages already mentioned, useful side effects of using the spacer include the option to adjust the height of the substructure and that the loads are distributed evenly.

Cork pad spacer

Self-adhesive



Art. no.	Dimensions [mm] ^{a)}	Material	PU
100348	3 x 60 x 60	Cork	25
100349	6 x 60 x 60	Cork	25
100350	10 x 60 x 60	Cork	25

^{a)} Height x length x width



TAKE A LOOK AT OUR APPLICATION VIDEOS!



Roof-protection cork

The natural underlay for adjustable pedestals



Art. no.	Dimensions [mm] ¹⁾	Material	PU
945395	3 x 200 x 200	Cork	10

¹⁾ Height x length x width

Using adjustable deck pedestals on, for example, PVC sheet roofs can lead to problems because of the plasticisers contained in the roofing. The roof-protection cork provides natural protection against mechanical damage to the roof sheeting, at the same time as preventing contact between the two materials. Free of PAHs (hazardous plasticisers in rubber).

ACCESSORIES FOR DECKING SUBSTRUCTURES

Root control fleece underlay



Art. no.	Dimensions [m]	Material	PU
944799	1,6 x 10,0	Polypropylene 50g/m ²	1

ADVANTAGES

- Permeable Polypropylene underlay
- Very limited permeability to water
- Inhibits plant growth under the fleece



Application example Root control underlay

Rolfi, spacers



Art. no.	Dimensions [mm] ¹⁾	Material	PU
945966	3 x 60 x 60	EPDM, black	25
945967	6 x 60 x 60	EPDM, black	25
945379	10 x 60 x 60	EPDM, black	25

¹⁾ Height x length x width

These spacers form a gap between the substructure and the foundation / support and thus help to protect the wood of the boarding beams.

ADVANTAGES

- Height adjustment of the substructure possible
- Even load distribution, minor irregularities are balanced out
- Dampens footfall noise



Rolfi spacer in combination with timber substructure.

Protectus, timber-protection tape



Art. no.	Dimensions [mm] ^{o)}	PU
946157	0,5 x 75 x 20.000	1

^{o)} Height x width x length

The Protectus timber-protection tape provides lasting protection for your timber substructure from moisture, e. g. rain.

ADVANTAGES

- Structural wood protection
- Thanks to the high-tear-resistance PE spectral film, it is easy to apply
- Optimal fit thanks to the very thin material
- Tear-proof and permanently resistant
- Screws can simply be screwed through it
- Can be individually cut to length



Application example Protectus, timber-protection tape

Rolfi roll



Art. no.	Dimensions [mm] ^{o)}	Material	PU
945561	8 x 2015 x 70	Granulated rubber	10

^{o)} Height x length x width

The Rolfi roll forms a gap between the deck substructure and foundation / subsurface.

ADVANTAGES

- Constructive timber protection
- Substructure height can be adjusted
- Uniform load distribution
- Small irregularities can be evened out
- Dampens footfall noise
- Can be individually cut to length



Application example Rolfi roll



ADJUSTABLE PEDESTALS AND ACCESSORIES

3





OVERVIEW OF EUROTEC ADJUSTABLE PEDESTALS

						
	BASE	SL BASE	PRO	SL PRO	GIANT	PRO CERA
	25 – 210 mm	32 – 217 mm	10 – 168 mm	55 – 102 mm	40 – 220 mm	42 – 202 mm
	2,2 kN	2,2 kN	8 kN	8 kN	22 kN	8 kN
	✓	✓	✓	✓	–	–
	–	–	✓	–	✓	✓
	–	✓	–	✓	–	✓
	–	–	✓	✓	✓	✓

KEY



Assembly height



Load-bearing capacity



For timber decks/WPC



For stone deck



Self-levelling



Can be expanded with expansion ring

COMBINATION OPTIONS

						
	BASE	SL BASE	PRO	SL PRO	GIANT	PRO CERA
 EVO	✓	✓	✓	✓	—	—
 EVO Slim	✓	✓	✓	✓	—	—
 EVO Light	✓	✓	✓	✓	—	—
 Eveco	✓	✓	✓	✓	—	—
 HKP	✓	✓	✓	✓	—	—
 Nivello 2.0	—	—	✓	—	✓	—
 TERRA H15	✓	✓	✓	✓	—	—
 TERRA H24	✓	✓	✓	✓	—	—
 TERRA H50	✓	✓	✓	✓	—	—
 TERRA H85	✓	✓	✓	✓	—	—

Please note that not all profiles are available in black – this colour is available on request.



ADJUSTABLE PEDESTALS BASE-LINE

ADVANTAGES

- Suitable for substructures made of aluminium and timber
- Four different sizes available
- Assembly heights of 25 – 210 mm
- Load-bearing capacity of 2,2 kN/ pedestal

THE ADJUSTABLE PEDESTALS SERIES IS COMPLETED
BY FOUR DIFFERENT TYPES OF ADAPTER:

BASE L adapter

for classic timber substructures or modern aluminium substructures

BASE adapter 32/40/60

for clicking Eurotec aluminium profiles into place in a
time-saving manner



BASE-LINE S
Assembly height 25–40 mm



BASE-LINE M
Assembly height 35–60 mm



BASE-LINE L
Assembly height 60–110 mm



BASE-LINE XL
Assembly height 110–210 mm

COMBINATION OPTIONS



HKP



EVO



EVO Slim



EVO Light



Eveco



TERRA H15



TERRA H24



TERRA H50



TERRA H85

Please note that not all profiles are available in black – this colour is available on request.

Adjustable pedestal BASE



Art. no.	Name	Assembly height [mm]	Load-bearing capacity [kN]*	PU**
100000	BASE S	25 – 40	2,2	50
100001	BASE M	35 – 60	2,2	50
100002	BASE L	60 – 110	2,2	30
100003	BASE XL	110 – 210	2,2	20

*The quoted load-bearing capacities represent recommended values. With these loads, the adjustable pedestals only deform by approx. 2 mm. The load-bearing capacity before actual fracture is multiple times higher.

**The BASE adjustable pedestal is supplied with the BASE L adapter and one screw each per adjustable pedestal as standard. If the BASE adjustable pedestals are used for aluminium, suitable adapters must be purchased too.

Note

The BASE-Line is not compatible with the Nivello 2.0

BASE L adapter



Art. no.	Name	PU*
	BASE adapter L	

*The BASE L adapter is included in the scope of delivery as standard.

For aluminium or timber profiles. Suitable for BASE 1, 2, 3 and 4.

BASE adapter 32



Art. no.	Name	PU
100004	BASE adapter 32	10

For aluminium profiles with Click system. Suitable for EVO Light aluminium system profile.

BASE adapter 40



Art. no.	Name	PU
100005	BASE adapter 40	10

For aluminium profiles with Click system. Suitable for Eveco aluminium system profile.

BASE adapter 60



Art. no.	Name	PU
100006	BASE adapter 60	10

For aluminium profiles with Click system. Suitable for EVO / EVO Slim aluminium system profile and HKP deck-support profile.



Adjustable pedestal BASE with BASE adapter 32 and aluminium system profile EVO Light



Adjustable pedestal BASE with aluminium system profile EVO Light



ADJUSTABLE PEDESTALS SL BASE

The Eurotec adjustable pedestal SL BASE is ideal for the laying of decking substructures for outdoor use. The head of the adjustable pedestal SL BASE is self-adjusting and compensates for slopes on surfaces and terrain unevenness of up to 7%. The adjustable pedestal SL BASE also allows the simple creation of slopes of 1 – 2% of the terrace surface for draining purposes.

ADVANTAGES

- Suitable for substructures of aluminium and wood
- Available in four different sizes
- Assembly height of 32 – 217 mm
- Load-bearing capacity of up to 2,2 kN/pedestal



THE ADJUSTABLE PEDESTALS SL BASE IS COMPLETED BY THREE DIFFERENT TYPES OF ADAPTER:

SL BASE-L adapter

for classic timber substructures or modern aluminium substructures

SL BASE adapter 40 and 60

for clicking Eurotec aluminium profiles into place in a time-saving manner



SL BASE S
Assembly height 32–47 mm



SL BASE M
Assembly height 42–67 mm



SL BASE L
Assembly height 67–117 mm



SL BASE XL
Assembly height 117–217 mm

COMBINATION OPTIONS



HKP



EVO



EVO Slim



EVO Light



Eveco



TERRA H15

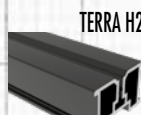

TERRA H24

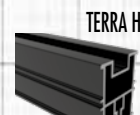

TERRA H50

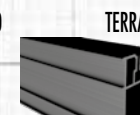

TERRA H85

Please note that not all profiles are available in black – this colour is available on request.

Adjustable pedestal SL BASE



Art. no.	Name	Assembly height [mm]	Load-bearing capacity [kN]*	PU**
100000-SL	SL BASE S	32 – 47	2,2	40
100001-SL	SL BASE M	42 – 67	2,2	30
100002-SL	SL BASE L	67 – 117	2,2	30
100003-SL	SL BASE XL	117 – 217	2,2	20

The height-adjustable support pedestals are suitable for predominantly static, centric compressive stress in multiple-supported systems.

*The quoted load-bearing capacities represent recommended values. With these loads, the adjustable pedestals only deform by approx. 2 mm. The load-bearing capacity before actual fracture is multiple times higher.

**The SL BASE-L adapter is included in the scope of delivery as standard.

SL BASE-L adapter



Art. no.	Name	PU*
	SL BASE-L adapter	

*The SL BASE-L adapter is included in the scope of delivery as standard.

For aluminium or timber profiles.

SL BASE adapter 40



Art. no.	Name	PU
100005-SL	SL BASE adapter 40	10

For aluminium profiles with Click system. Suitable for Eveco aluminium system profile.

SL BASE adapter 60



Art. no.	Name	PU
100006-SL	SL BASE adapter 60	10

Suitable for EVO/EVO Slim aluminium system profile and HKP deck-support profile.

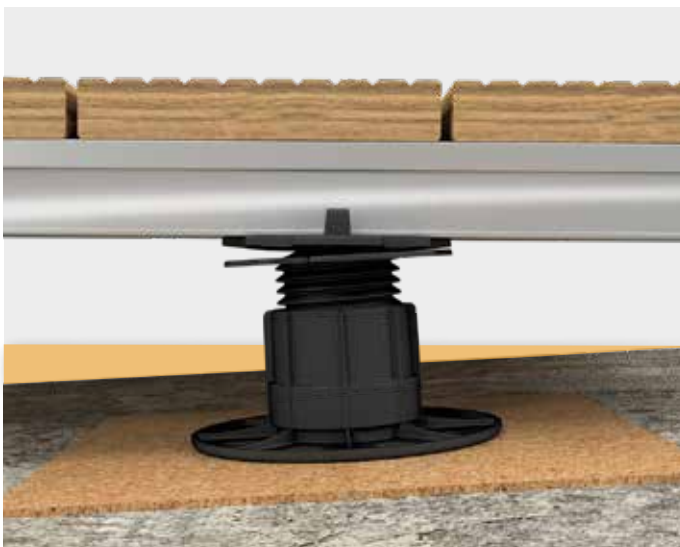

Example of application aluminium substructures



Example of application timber substructures



ADJUSTABLE PEDESTALS PROFI-LINE

Innovative, universal, versatile and user-friendly!

The PRO adjustable pedestals are suitable for timber decks and stone deck with various assembly heights. The series comprises six adjustable pedestals of different heights. Their assembly heights can be altered with extension rings or extension plates.

ADVANTAGES

- High load-bearing capacity of up to 8,0 kN/pedestal
- Basic assembly heights of 10 – 168 mm
- Additional heights possible with the extension rings and extension plate
- Quick and easy assembly
- Stepless height adjustment
- Resistant to weather, UV

THE ADJUSTABLE PEDESTALS SERIES IS COMPLETED BY THREE DIFFERENT TYPES OF ADAPTER:

L adapter

for classic timber substructures or modern aluminium substructures

Click adapter

for clicking Eurotec aluminium profiles into place in a time-saving manner

Stone adapter

for laying stone slabs



PRO XXS

Assembly height 10–15 mm



PRO XS

Assembly height 22–30 mm



PRO S

Assembly height 30–53 mm



PRO M

Assembly height 53–82 mm



PRO L

Assembly height 70–117 mm



PRO XL

Assembly height 74–168 mm

COMBINATION OPTIONS



HKP



EVO



EVO Slim



EVO Light



Eveco



TERRA H15

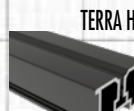

TERRA H24



TERRA H50



Nivello 2.0



TERRA H85

Please note that not all profiles are available in black – this colour is available on request.

Adjustable pedestal PRO

Fixing by means of Thermofix screw 4,2 x 22 mm (art. no. 945969) is possible on all PRO pedestals.

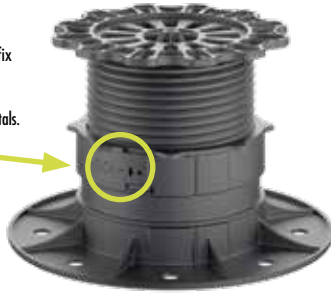

Art. no.	Name	Assembly height [mm]	Load-bearing capacity [kN]*	PU
954020	PRO XXS	10 – 15	4,0	50
954021	XXS extension plate	5	4,0	50
954061	PRO XS	22 – 30	8,0	20
946070	PRO S	30 – 53	8,0	10
946071	PRO M	53 – 82	8,0	10
946072	PRO L	70 – 117	8,0	10
946079	PRO XL	74 – 168	8,0	10

The PRO XXS comes with both an L adapter and stone adapter. The adjustable foot XXS can be combined with up to two extension plates XXS for height expansion.

Note: The adapters for the XXS adjustable pedestal are only suitable for the XXS and cannot be combined with the rest of the PRO family. Not compatible with the Nivello 2.0.

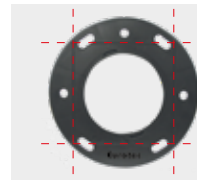

If necessary, the base plate of the adjustable feet PRO and SL PRO can be easily cut with a cutting knife along the cutting marks.

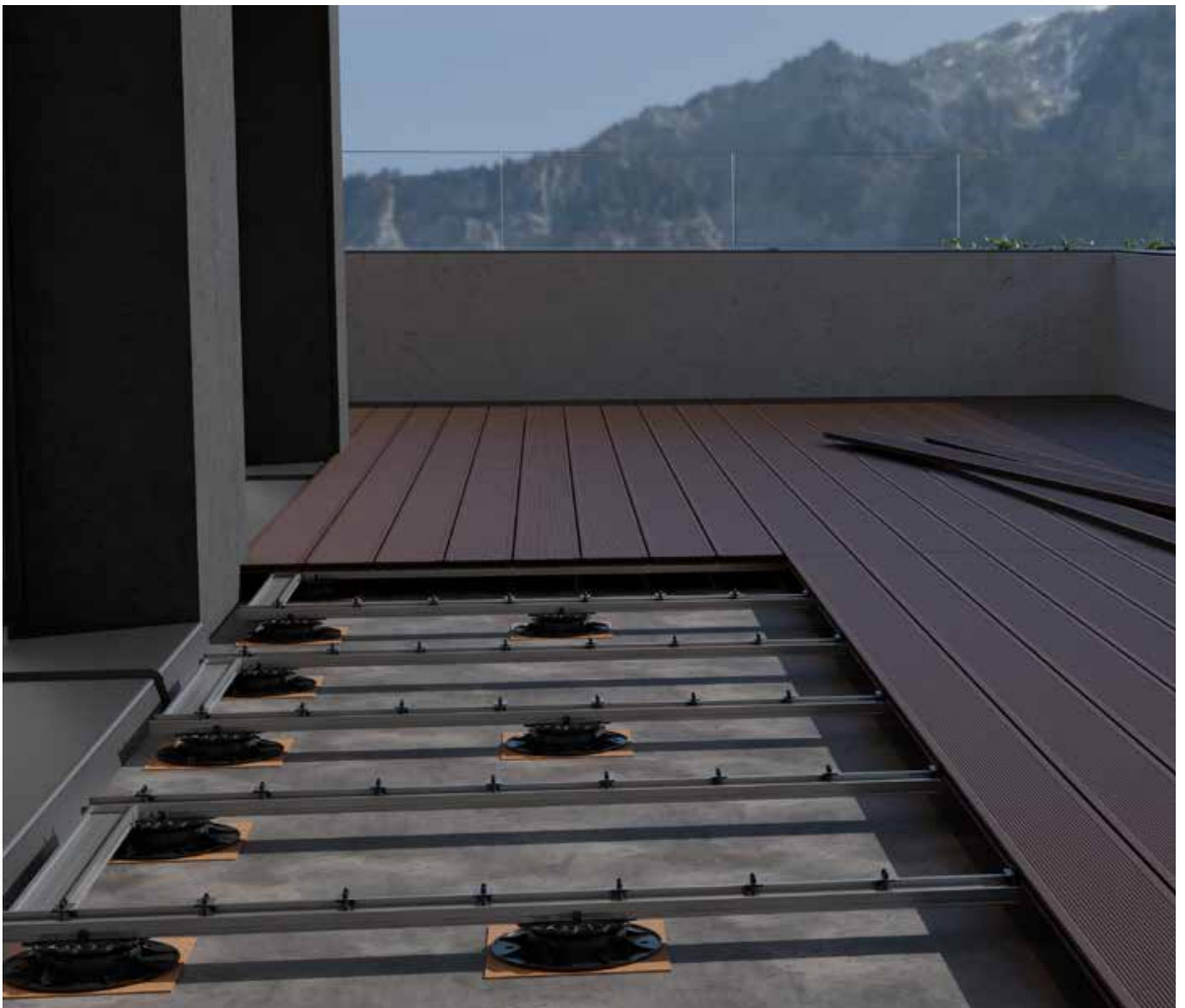

Substructure with PRO adjustable pedestals, click adapter 60, EVO aluminium system profile and Twin system holder

ACCESSORIES PROFI-LINE

Extension rings



Art. no.	Name	Assembly height [mm]	Load-bearing capacity [kN]*	PU
946069	Extension ring + 2	20	8,0	40
946074	Extension ring + 4	40	8,0	10
946073	Extension ring +10	100	8,0	10

*The quoted load-bearing capacities represent recommended values. With these loads, the adjustable pedestals only deform by approx. 2 mm. The load-bearing capacity before actual fracture is multiple times higher.

For increasing the height of the adjustable pedestals PRO and SL PRO.
Suitable for the PRO S, M, L and XL as well as SL PRO M and L adjustable pedestals.

L adapter



Art. no.	Name	PU**
946075	L adapter	10

**The product comes supplied with one screw per adapter.

For aluminium or timber profiles. Suitable for the PRO S, M, L and XL as well as SL PRO M and L adjustable pedestals.

Click adapter



Art. no.	Name	PU
946076	Click adapter 40	10
946077	Click adapter 60	10

For aluminium profiles with Click system.

Click adapter 40 for Evcco aluminium system profile. Suitable for PRO S – PRO XL.

Click adapter 60 for EVO/EVO Slim aluminium system profile and HKP deck-support profile. Suitable for PRO S – PRO XL.

Stone adapter



Art. no.	Name	Dimensions joint space [mm] ¹⁾	PU
946078	Stone adapter	8 x 14 x 4	10

¹⁾ Height x length x width

For stone slabs. Suitable for the PRO S, M, L and XL adjustable pedestals.



Standalone support is made possible by using the stone adapter.



Standalone support is made possible by using the stone adapter.

Adjustable pedestals	Possible combinations					
	L adapter	Click adapter 40	Click adapter 60	Stone adapter	L/stone adapter XXS	L/stone adapter XS
PRO XXS					✓	
PRO XS						✓
PRO S	✓	✓	✓	✓		
PRO M	✓	✓	✓	✓		
PRO L	✓	✓	✓	✓		
PRO XL	✓	✓	✓	✓		
SL PRO M	✓					
SL PRO L	✓					

Nivello 2.0

For PRO-Line adjustable pedestals



Art. no.	Slope (%)	PU
946035	0,5 – 10	10

The Nivello 2.0 is a washer that can be mounted beneath the Eurotec Profi-Line series S – XL of adjustable pedestals in order to level out slight slopes or inclines in an installation surface.

ADVANTAGES

- User-friendly operation
- Versatile slope adjustment
 - Minimum slope 0,5 %
 - Maximum slope: 10 %
 - Slope can be adjusted in steps of 0,5 %
- Click-locking of adjustable pedestals
- Bearing surface composition protects subsurface (e. g. roofing)
- Large bearing surface

Not compatible with adjustable pedestals PRO XS, PRO XXS and BASE-Line.



Levelling out slopes with Nivello 2.0



ADJUSTABLE PEDESTALS SL PRO

The Eurotec SL PRO adjustable pedestal is suitable for installing deck substructures in outdoor applications. The head of the SL PRO adjustable pedestal features stepless self-levelling and ensures that slopes of up to 8 % on surfaces and uneven ground can be evened out. The most important advantage is, that no additional slope compensation is required to establish the correct alignment of the covering surface. The SL PRO adjustable pedestal therefore allows the easy creation of an inclination of 1 – 2 % on deck surfaces for drainage purposes.

ADVANTAGES

- Self-levelling for slopes of up to 8 %
- UV stability
- High fatigue strength
- Stepless height adjustment from 55 to 102 mm
- Excellent chemical resistance
- Acoustic damping properties

THE SL PRO ADJUSTABLE PEDESTAL SERIES IS COMPLETED BY THE FOLLOWING PRODUCTS:

L Adapter and Click Adapter

For classic timber or modern aluminium substructures.

Extension rings + 4 und +10

To increase the adjustable pedestals' height.



SL PRO M UND L
Assembly height **M** 55–84 mm
Assembly height **L** 73–102 mm



**CONTINUOUS
SELF-ADJUSTING
OF UP TO 8 %**

COMBINATION OPTIONS

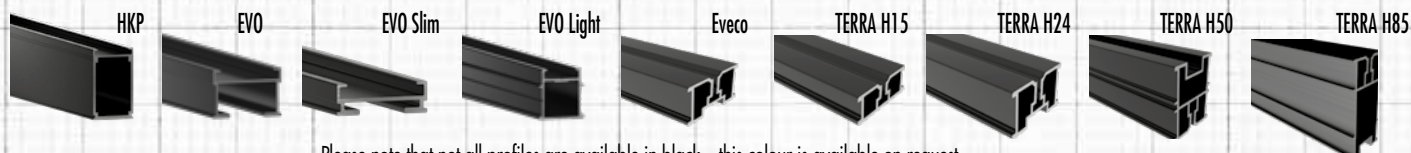

Please note that not all profiles are available in black – this colour is available on request.

Adjustable pedestal SL PRO



Art. no.	Name	Adjustable range [mm]	Load-bearing capacity [kN]*	PU
946071-SL	SL PRO M	55 – 84	8,0	10
946072-SL	SL PRO L	73 – 102	8,0	10

The adapter must be attached to produce an assembly height in the adjustment range!

*The quoted load-bearing capacities represent recommended values. With these loads, the adjustable pedestals only deform by approx. 2 mm. The load-bearing capacity before actual fracture is multiple times higher.

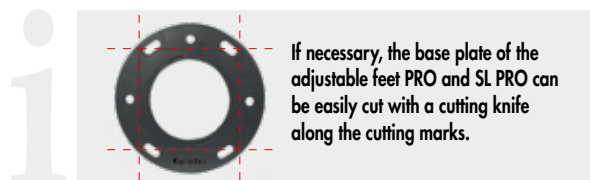

If necessary, the base plate of the adjustable feet PRO and SL PRO can be easily cut with a cutting knife along the cutting marks.



Uneven base surface is levelled out



Uneven base surface is levelled out

ACCESSORIES

L adapter



Art. no.	Name	PU**
946075	L adapter	10

**The product comes supplied with one screw per adapter.

For aluminium or timber profiles. Suitable for the PRO S, M, L and XL as well as SL PRO M and L adjustable pedestals.

Extension rings



Art. no.	Name	Assembly height [mm]	Load-bearing capacity [kN]*	PU
946069	Extension ring + 2	20	8,0	10
946074	Extension ring + 4	40	8,0	10
946073	Extension ring +10	100	8,0	10

*The quoted load-bearing capacities represent recommended values. With these loads, the adjustable pedestals only deform by approx. 2 mm. The load-bearing capacity before actual fracture is multiple times higher.

For increasing the height of the adjustable pedestals PRO and SL PRO. Suitable for the PRO S, M, L and XL as well as SL PRO M and L adjustable pedestals.

LOAD DISTRIBUTION PLATE

Accessories for the BASE and PRO adjustable pedestal

Installing a terrace on an **insulated flat roof** often gives rise to difficulties with regard to load and **load distribution**. Insulating materials can press through the terrace base at certain points, thereby damaging the insulation and the flat roof. With the **Eurotec load distributing plate**, by contrast, the load on the terrace base is spread over a greater surface and **distributed more evenly** across the terrace. In contrast to **other load distribution options** (such as stone slabs and wooden panels), load distributing plates are much more durable and easier to transport; they also weigh far less.

Load distributing plates can be combined with our **PRO, SL PRO, BASE and SL BASE adjustable pedestals**, our **EVO and EVO Slim aluminium system profiles** and the **HKP aluminium support profile**.

Load distribution plate



Art. no.	Dimensions [mm] ^{*)}	Material	PU
100016	28 x 210 x 210	PP-C (Polypropylene-copolymer)	10

*) Height x length x width

ADVANTAGES

- Fast and easy assembly thanks to the click system
- Controlled load distribution
- Low weight helps to protect the subsurface
- Ease of transport, in contrast to alternative designs
- Durable and resistant to UV radiation and rot
- Low installation height compared to conventional load distribution solutions



Load distribution plate + PRO M



Load distribution plate + BASE

USING THE LOAD DISTRIBUTION PLATE



In the first step, the load distributing plate is placed on the flat roof.



Place an adjustable pedestal on the load distributing plate and click to lock.



A click adapter is then attached to the adjustable pedestal.



Finally, the aluminium profile is connected to the construction.

Note

Observe permitted compressive stress of the present insulation at 2 % compression! For point loads such as heavy plant containers or pool constructions, appropriate measures need to be taken to strengthen the structure (e. g. placing the adjustable feet closer together and/or reducing spacing in the substructure and/or using appropriate load distribution plates).

REDUCE COMPRESSIVE STRESSES ON INSULATED SURFACES: LOAD DISTRIBUTION PLATES AS A SOLUTION FOR TERRACE STRUCTURES

If you are planning a terrace on an insulated base surface, you should observe the permitted **continuous compressive stress**. As the adjustable pedestal have small contact surfaces, which causes **compressive stress** on the insulation, the continuous compressive stress can be exceeded even under normal loads and spacing dimensions.

Using the load distribution plate **increases the contact surface**, which **reduces the compressive stress of the adjustable pedestal**.

The example in the table shows that the load distribution plate reduces the support stress below the example insulation's maximum permitted value for continuous compressive stress in combination with the PRO adjustable foot.

Product	Compressive stress of insulation ^{a)}	
	Continuous compressive stress ^{b)}	Compressive stress under full load ^{d)}
	for $\sigma_{0,2\%}$ [kPa]	for $\sigma_{0,10\%}$ [kPa]
Adjustable pedestal PRO	39	138
PRO + Load distribution plate	21	75
Reducing the compressive stress with the load distribution plate		-46 %
Compressive stress of insulation ^{d)}	30	120

^{a)}Compressive stress arising from the load between support (adjustable foot) and, for example, slope insulation.

Values for: Adjustable foot spacing 0.50 m x 0.50 m; dead load of terrace $g = 0.8 \text{ kN/m}^2$; load capacity $p = 4.0 \text{ kN/m}^2$

^{b)}Load assumption: 1.0 g + 0.5 p; continuous compressive stress of insulation at 2 % compression as decisive factor

^{c)}Load assumption: 1.35 g + 1.5 p; compressive stress of insulation at 10 % compression as decisive factor

^{d)}Example insulation: products with lower or higher values on the market.

Attention

Check the assumptions made. The specified values, type and number of fasteners are planning aids. Projects must only be calculated by authorised persons. Please contact an approved structural engineer for free verification of stability. We will be happy to refer you to someone.

FLEXI GROUND ANCHOR

Acts as a foundation

The Flexi ground anchor by Eurotec **acts as a foundation for low terraces**. It allows a terrace to be extended even without a stable foundation (depending on soil composition) and can be used without time-consuming excavation and setting in concrete.

The shape allows the centre of the ground anchor **to be driven into the loose soil (e. g. a lawn) using a hammer**. It should be noted that the ground anchor **does not have an impact surface and it could deform if driven into firm ground!**

Finally, an adjustable foot is affixed to the FLEXI ground anchor and the substructure and deck structure are applied. In this way, the danger of the adjustable feet sinking into the ground is reduced. **To be used with Eurotec adjustable pedestals except GIANT.**

FLEXI ground anchor



Art. no.	Dimensions [mm] ^{a)}	Ø Baseplate [mm]	Material	PU
975680	300 x 140	200	Polypropylene	1

^{a)} Height x width

ADVANTAGES

- No excavation or setting in concrete necessary
- Can be driven into the ground quickly and easily
- Reduces sinking of the adjustable feet



Expand the terrace foundation with the FLEXI ground anchor.

USING THE FLEXI GROUND ANCHOR



1 Drive the ground anchor into the ground using a hammer.



2 Once the ground anchor has been fully driven into the ground, position the adjustable pedestal onto the head plate.



3 The adjustable pedestal can be attached to the head plate by using Thermofix or BiGHTY drilling screws.



4 Finally, continue with the standard assembly of the terrace substructure – done!

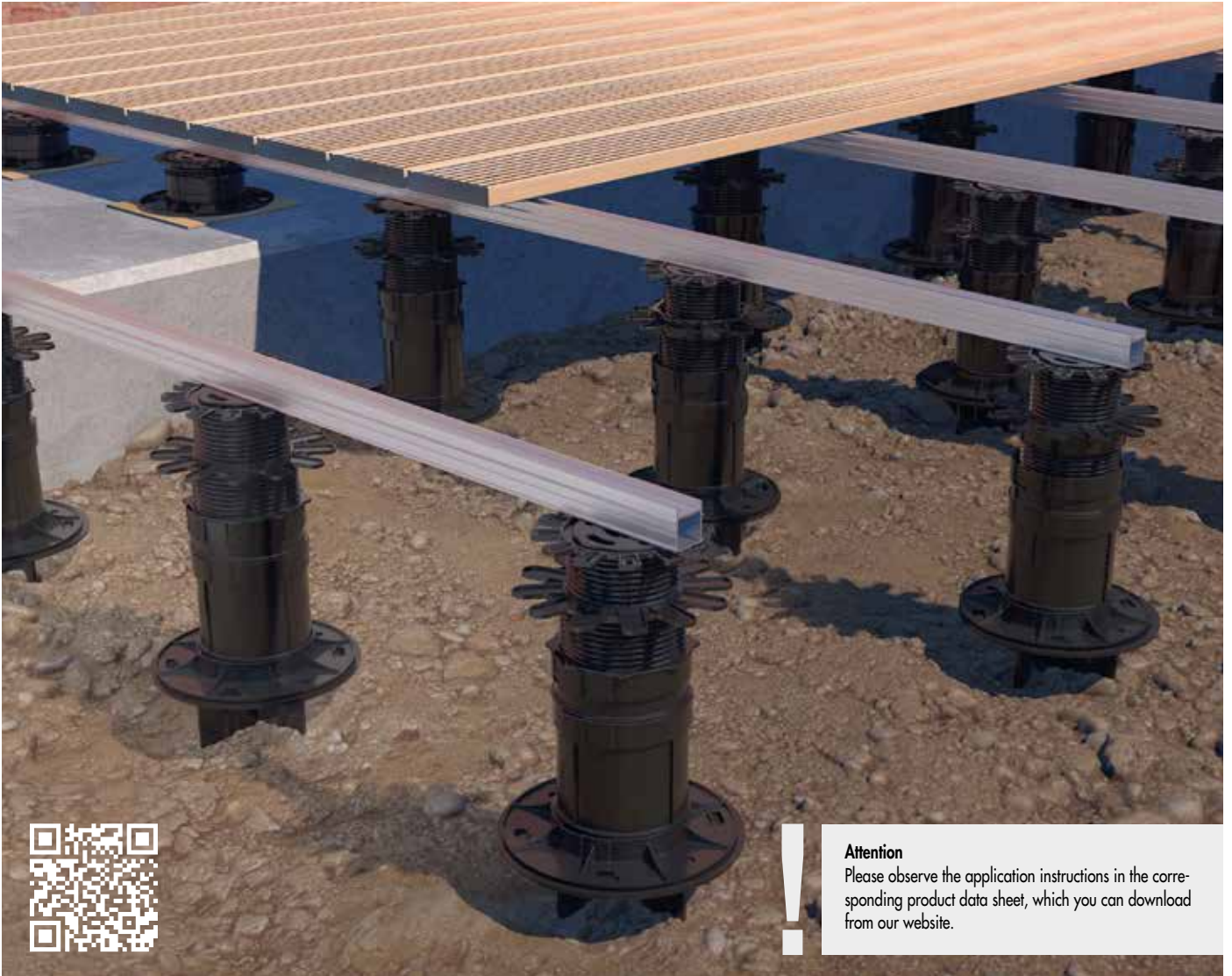

FLEXI ground anchor as a stable foundation for the terrace substructure.



ADJUSTABLE PEDESTALS PRO CERA



PRO CERA adjustable pedestals are suitable for stone terraces in a range of installation heights.

Thanks to this innovative solution, the support surface can be flexibly adjusted to gradients of up to 7%; yet it still remains a stable part of the resulting structure. The 4 mm wide joint spacers ensure that the stone slabs are automatically aligned with each other and produce a consistent joint width. Thanks to a predetermined breaking point, they can be removed to achieve a range of different installation types. The series includes six adjustable pedestals in different heights, which can be flexibly adjusted with the help of our PRO extension rings

ADVANTAGES

- High load capacity of 8.0 kN/ft
- Continuously adjustable to gradients of up to 7 %
- Basic overall installation heights between 42,8 to 170,8 mm
- Greater heights are possible with expansion rings
- Quick and easy installation
- Infinitely variable height adjustments



PRO CERA XS
Assembly height
42,8–50,8 mm



PRO CERA S
Assembly height
50,3–65,8 mm



PRO CERA M
Assembly height
65,3–80,8 mm



PRO CERA L
Assembly height
72,8–88,3 mm



PRO CERA XL
Assembly height
82,8–130,8 mm



PRO CERA XXL
Assembly height
122,8–170,8 mm

COMBINATION OPTIONS

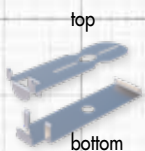

TERRA edge finish
single support



Roof protection cork



Height extension:
22,5 mm



Height extension:
40 mm



Height extension:
100 mm

LOOKING FOR LOW INSTALLATION HEIGHTS?

PROFI-LINE XXS, XS AND S

- Suitable for timber and stone terraces
- Extended heights are possible with extension rings
- Installation heights: 10–53 mm
- Load capacity: 8.0 kN/ pedestal

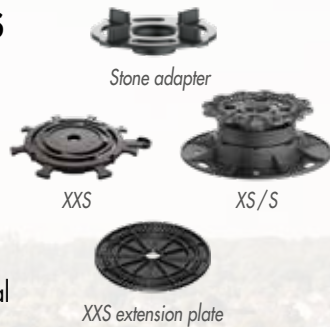

SLAB SUPPORT

- Assembly height: 10 mm, 20 mm
- Up to three units can be stacked on top of one another
- Surface water can quickly and easily run off through the grooves



IMPATE PLATE



SELF-LEVELLING SUPPORT PLATE



THREADS



EXTENSION RING WITH THREADED RING



BOTTOM SECTION

ADJUSTABLE PEDESTALS PRO CERA



Adjustable pedestals PRO CERA				
Art. no.	Product description	Assembly height [mm]	Height extension ring* [mm]	PU
946055	PRO CERA Pedestals XS	42,8–50,8	–	10
946057	PRO CERA Pedestals S	50,3–65,8	–	10
946058	PRO CERA Pedestals M	65,3–80,8	22,5	10
946059	PRO CERA Pedestals L	72,8–88,3	22,5	10
946060	PRO CERA Pedestals XL	82,8–130,8	40	10
946061	PRO CERA Pedestals XXL	122,8–170,8	2 x 40	8

* Included in the scope of delivery.



The joint spacers can be broken off individually

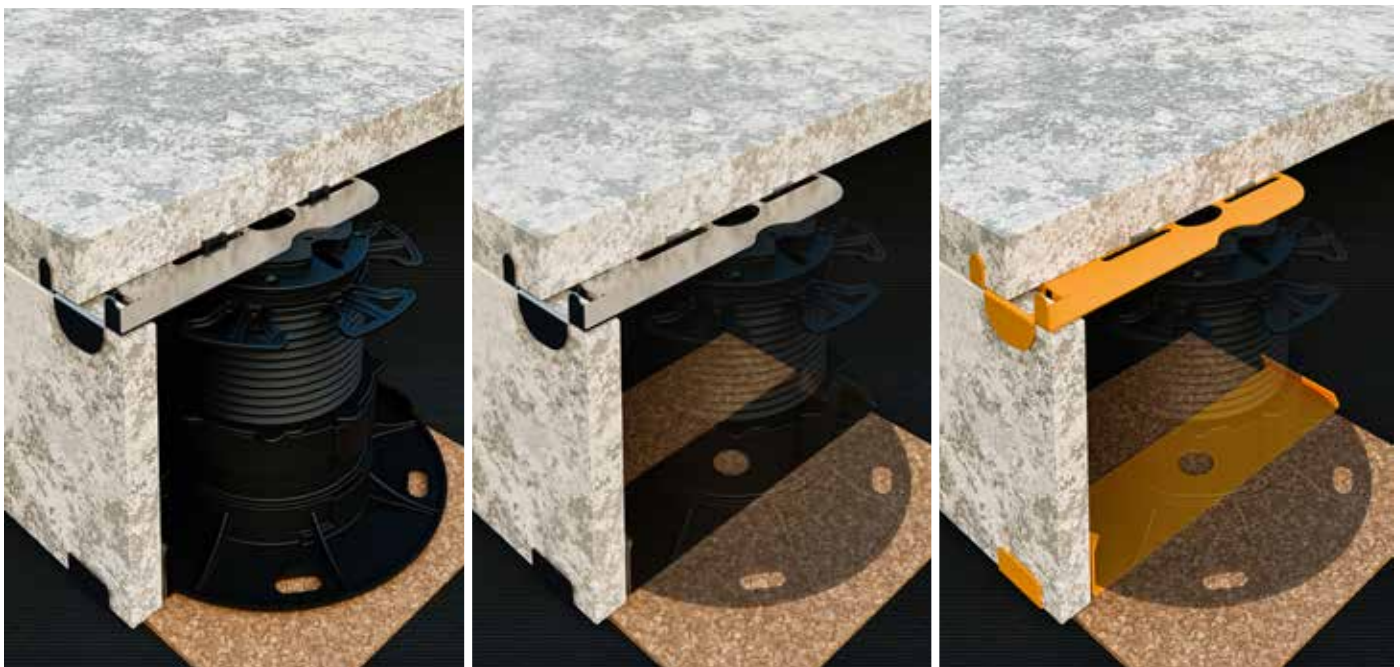

Edge finish with the PRO CERA adjustable pedestal in combination with the TERRA edge finish standalone support.

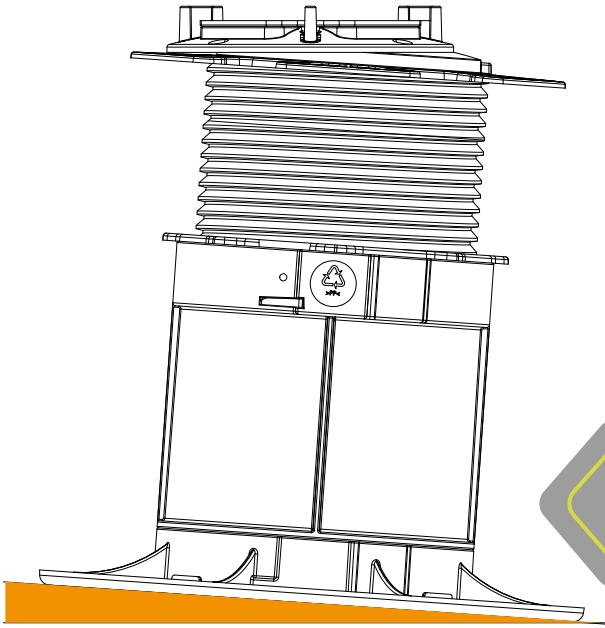

OFFSETS SLOPES
OF UP TO 7 %!

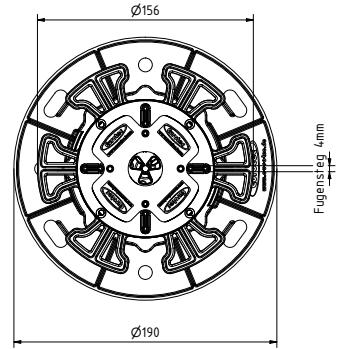

Top view

RECOMMENDED SUPPORT FOR STONE COVERINGS

Standalone support with adjustable feet

When you are building a stone terrace with no substructure, it is especially important to use appropriate adjustable feet. They support the stone slabs and stop them from breaking, resulting in a stable and sturdy terrace. The number of adjustable feet required and the best way to position them is determined by the size of slabs used. The following example serves as a guide. It can be used to identify the required support of the terrace slabs in connection with a standalone support.

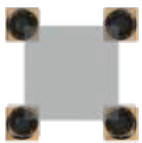

60 x 60 cm

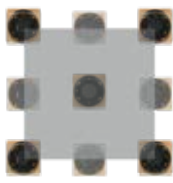

80 x 80 cm

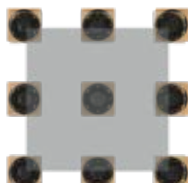

90 x 90 cm

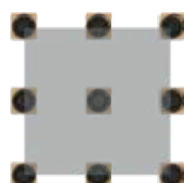

120 x 120 cm



80 x 40 cm



120 x 40 cm



90 x 60 cm

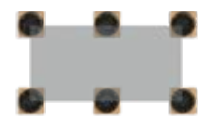

120 x 60 cm

Important

Observe the manufacturer's instructions for supporting the stone slabs! Using our system does not release planners / processors from their duty to find out about the manufacturer's specifications for other products (installed together with our system).



ADJUSTABLE PEDESTALS GIANT

Our GIANT adjustable pedestals are specially designed for the individual support of heavy, large-format stone slabs and ceramic tiles. The adjustable feet are available in four different variants, spanning an infinitely variable range of 40 to 220 mm. The GIANT extension ring raises the installation height by a further 170 mm.

The GIANT adjustable foot is also characterised by a very high load capacity. In the assembled state, loads of up to 22 kN/pedestal* are possible, compared to just 19 kN/pedestal* when combined with the GIANT extension ring.

ADVANTAGES

- High load capacity of up to 22 kN/pedestal*
- Pre-installed impact noise disc absorbs impact noise
- For the individual support of heavy, large-format stone slabs/ceramic tiles
- Infinitely adjustable heights from 40 to 220 mm
- The GIANT extension ring raises the height by another 170 mm
- Can be extended with max. one extension ring
- Resistant to weather, UV exposure, insects and rot



GIANT S
Assembly height 40–55 mm



GIANT M
Assembly height 55–85 mm



GIANT L
Assembly height 80–130 mm



GIANT XL
Assembly height 130–220 mm

COMBINATION OPTIONS

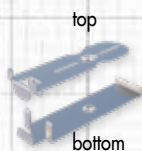

TERRA edge finish
single support



Nivello 2.0

THE GIANT ADJUSTABLE PEDESTAL SERIES IS COMPLETED BY THE FOLLOWING PRODUCTS:

Extension ring GIANT

For the height extension of the adjustable pedestals.

Adjustment key GIANT

For subsequent height adjustment

Impate plate

Made of Elasto, absorbs impact noise.

Stone adapter

For the individual support of stone slabs
The four clips stop stone slabs from slipping and ensure even joint spacing.

Thread

For infinitely variable adjustment of the installation height from 40 to 220 mm.

Base

Withstands very high loads of up to 22 kN / pedestal*

*Maximum load capacity when retracted.

Load capacity of 19 kN / pedestal when combined with the GIANT extension ring.

Adjustment key, Art. no.: 100014
Not included in the scope of supply.

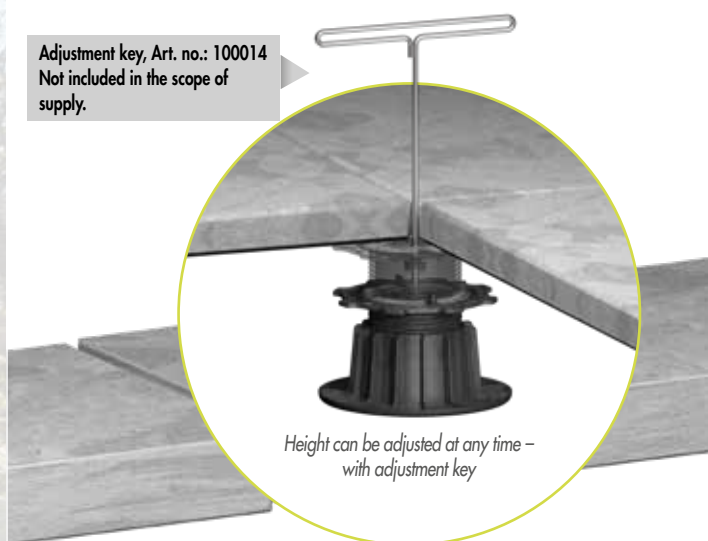

Adjustable pedestal
GIANT



Art. no.	Name	Assembly height [mm]	Load-bearing capacity [kN]*	Joint spacer [mm]	PU
100010	GIANT S	40–55	22	4	10
100011	GIANT M	55–85	22	4	10
100012	GIANT L	80–130	22	4	10
100013	GIANT XL	130–220	22	4	4

Extension ring GIANT



Art. no.	Assembly height [mm]	Load-bearing capacity [kN]*	PU
100015	110–170	19	10

Adjustment key GIANT



Important

Please refer to the product data sheet before using the adjustment spanner.

Art. no.	PU
100014	1

*Maximum load capacity when retracted. Load capacity of 19 kN / pedestal when combined with the GIANT extension ring.



**FOR EXTRA LARGE
STONE SLABS**

Can withstand loads of up
to 22 kN*!



Stone patio with adjustable pedestal GIANT

SUBSTRUCTURE FOR LARGE-SIZE STONE SLABS

Terraces with large stone slabs require additional support. This is provided by additional cross bracing or longitudinal bracing for the substructure and Flex Stone Clips, to stop the slab from breaking under load.

VARIANT 1: CROSS BRACING

Cross struts **every 30 cm** with one to two Flex Stone Clips (depending on slab width) serving as support points.

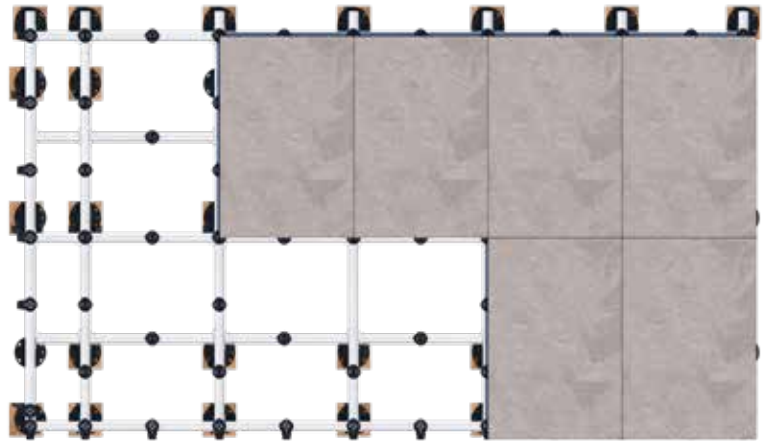

VARIANT 2: LONGITUDINAL BRACING

Place additional longitudinal struts under the centre of the stone slabs. Support points provided by Flex Stone Clips every 60 cm. The cross bracing is applied **every 75 cm** alternately.

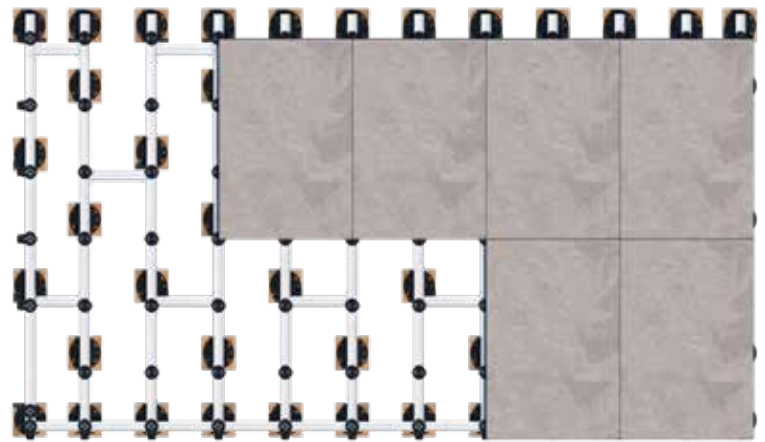

VARIANT 3: CROSS BRACING WITH SUPPORT CLIP AND EVO LIGHT

Cross struts **every 60 cm** with **EVO Light and the Support Clip** set as well as one to two **Flex Stone Clips** (depending on slab width) serving as support points.

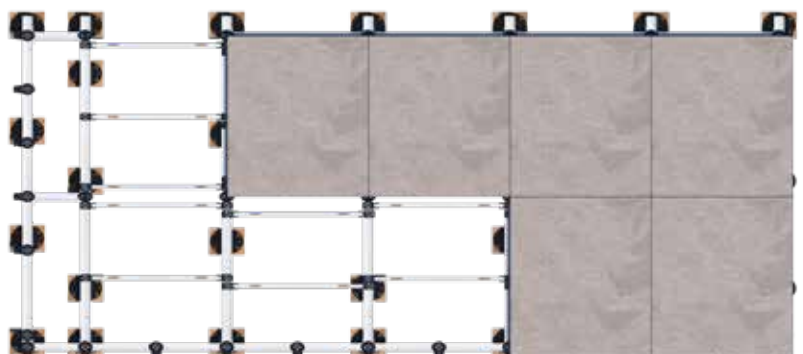

Important

Observe the manufacturer's instructions for supporting the stone slabs! Using our system does not release planners / processors from their duty to find out about the manufacturer's specifications for other products (installed together with our system).

Aids for installing stone slabs

Level surface with little effort

Also ideal for your roof terrace

Thanks to modern slab support and special adjustable pedestals for slabs, it is now possible to lay floor slabs easily and without mortar. The different support heights of the slab supports and adjustable pedestals allow you to easily correct height differences in the subfloor and to cover up unsightly outflows and drains. You can therefore achieve an even surface with little effort. Any surface water that arises can run off quickly and easily through the seams.

In order to achieve an even surface with the stone slabs, the height can be adjusted down to the last millimetre using gearwheels in the Quattro Lager.

Slab support EPDM



Art. no.	Dimensions [mm] ^{a)}	Material	PU
945432	Ø 120 x 18/10	EPDM, black	45

^{a)}Outside diameter x total height/Support height of a plate bearing

ADVANTAGES

- Secure, non-slip storage
- Up to three units can be stacked on top of one another
- Dampens footfall noise
- Suitable for low installation heights
- Surface water can quickly and easily run off through the grooves



Example of application slab support EPDM

Slab support PP



Art. no.	Dimensions [mm] ^{a)}	Joint spacer [mm]	Load-bearing capacity [kN]	Material	PU
945431	Ø 120 x 18/10	4	2	PP (Polypropylene)	50

^{a)}Outside diameter x total height/Support height of a plate bearing

ADVANTAGES

- Good UV stability
- Very good chemical resistance
- Surface water can quickly and easily run off through the grooves
- Up to three units can be stacked on top of one another

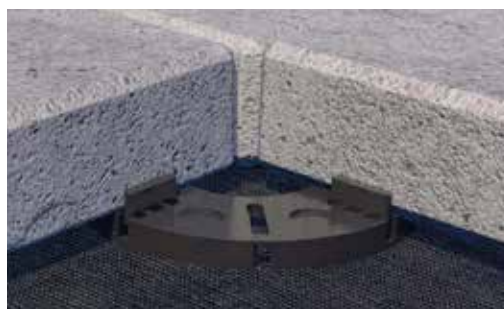

Example of application slab support PP

Shim

Suitable for this

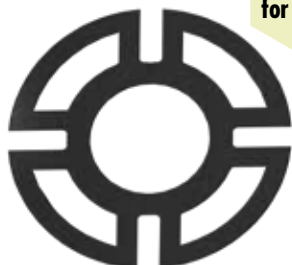

Art. no.	Dimensions [mm] ^{a)}	Joint spacer [mm]	Material	PU
954086	Ø 120 x 18/10	4	EPDM	50

^{a)}Outside diameter x total height/Support height of a plate bearing

Quantity calculation for slab support EPDM / PP

Baseplate	Piece/m ²
40 x 40 cm	ca. 7,8
50 x 50 cm	ca. 4,8
40 x 60 cm	ca. 5,6
60 x 60 cm	ca. 4,0

There are approximate figures based on an area of 25 m² (5 x 5 m).

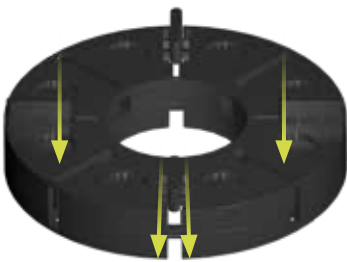

*Reduces negative pressure formation,
no water accumulation*



*Max. three pieces can be
stacked on top of each other*

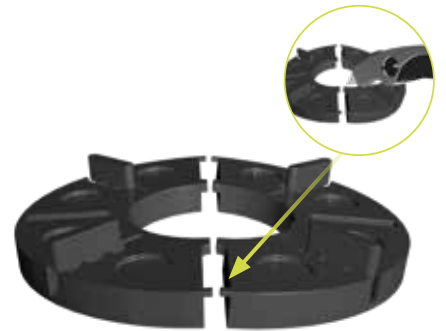

*To halve or quarter, break away at
the respective points.
Can also be cut through.*

SLAB BEARING PP LAID AT 2 % SLOPE

Depending on the condition of the substructure, a combination with the slab bearing made of EPDM from Eurotec would be recommended. Because the bearing's plastic does not harmonise with all underlays, we recommend the additional 1 mm compensating pads to ensure slip resistance at the same time.

In addition to levelling the slope, this makes it easy to compensate for unevenness in the stone surface.

NOTE

When laying on a slope, start laying at the highest point!

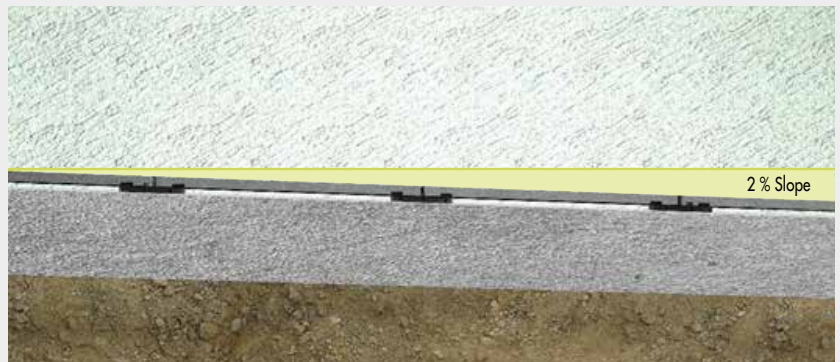
ASSEMBLY INSTRUCTION

When using slab supports, the terrace must be enclosed. This prevents the slab supports / terrace from moving. If the terrace is not enclosed, structural provision must be made for this. Edging = green marking. Levelling pads compensate for any slope or unevenness in the stone slabs. A subsequent check can be made with a spirit level.

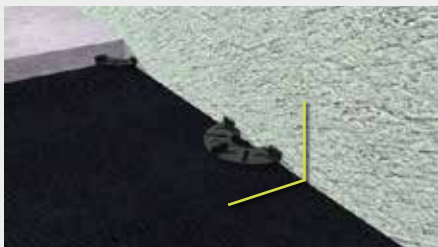

IMPACT PLATE Ø 90 MM

The Eurotec impact plate Ø 90 mm is used to **compensate for differences in the slabs** and to **dampen impact** sound when stone or ceramic slabs are laid on top. The impact plate Ø 90 mm **can be split up into four parts**.

Impact plate Ø 90

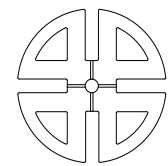
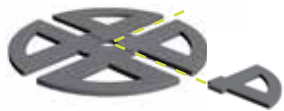

Art. no.	Dimensions [mm]	PU
954089	Ø 90; Height 2,5	50

ADVANTAGES

- Flexible use
- Cuttable
- Resistant to ageing
- UV-stable
- Resistant to ozone
- Permanently elastic & dimensionally stable

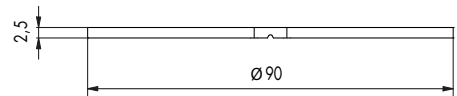

CAN BE COMBINED WITH:

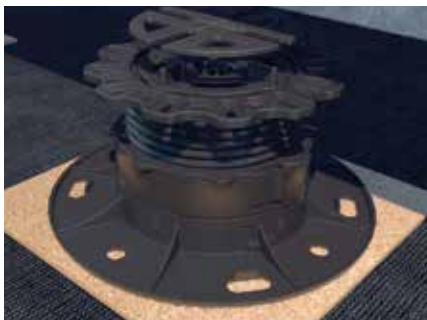

Adjustable pedestal PRO with impact plate



Flex-Stone-Clip with impact plate



Stone-Edge-Clip with impact plate

Quattro-Lager

With slab spacer



Art. no.	Dimensions [mm]	Load-bearing capacity per corner [kN]*	Total load capacity [kN]*	PU
945340	Ø 150 x 35 – 55	2,0	8,0	15

*The quoted load-bearing capacities represent recommended values.

ADVANTAGES

- Four different support heights are possible thanks to individually adjustable gearwheels.
- Support height: 35 – 55 mm
- Joint spacer: 6 mm
- The height can be extended by placing the Quattro Lager adapter underneath
- Can be split



Adapter

For Quattro Lager



Art. no.	Dimensions [mm]	Load-bearing capacity per corner [kN]*	PU
945342	Ø 150 x 20	8,0	20

*The quoted load-bearing capacities represent recommended values.

ADVANTAGES

- Support height: 20 mm
- Can be split
- Stackable

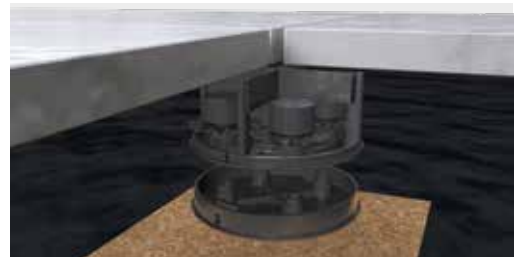

AIDS FOR INSTALLING STONE SLABS

Stone slab spacer

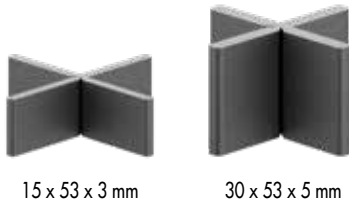

15 x 53 x 3 mm

30 x 53 x 5 mm

Art. no.	Dimensions [mm] ^{a)}	Material	PU
945336	15 x 53 x 3	PP	100
945338	30 x 53 x 3	PP	100
945335	15 x 53 x 5	PP	100
945337	30 x 53 x 5	PP	100

^{a)}Bridge height x length x joint dimension

Stone slab spacer

With baseplate



Art. no.	Dimensions [mm] ^{a)}	Material	PU
945339	15 x 53 x 3	PP	100

^{a)}Bridge height x length x joint dimension

Large baseplate prevents slab spacers from being pressed into gravel bed.

ADVANTAGES OF STONE SLAB SPACERS

- Uniform joint pattern
- Optimum drainage
- They prevent the floor slabs from rubbing against one another and therefore prevent damage to the slab edges.
- They have predetermined breaking points and are therefore suitable for T-joints and cross joints.
- Durable
- Resistant to temperature and weathering
- Resistant to acids, alkalis and other chemicals



Quantity calculation for laying floor slabs

Floor slab	Pieces/m ²
40 x 40 cm	ca. 7,8
50 x 50 cm	ca. 4,8
40 x 60 cm	ca. 5,6
60 x 60 cm	ca. 4,0

There are approximate figures based on an area of 25 m² (5 x 5 m).

Stone slab lifter



Art. no.	Span [cm]	Nominal Load [kg]	PU
954045	30,0 – 50,0	25	1

ADVANTAGES / PROPERTIES

- Simplifies and speeds up the lifting and laying of floor slabs.
- Also suitable for subsequent lifting of already laid slabs.



ROBUSTO DECK PEDESTAL

WHAT CAN IT BE USED FOR?

- Deck construction
- For example, for the construction of barrier-free ramps and transitions
- Thanks to its U-shaped head plate, the Robusto HV 500+350 can support not only the Eurotec HKP deck-support profile but also the EVO aluminium system profile and timber substructure profiles.

PROPERTIES

- Meets the requirements for structural wood protection

ADVANTAGES

- An EPDM gasket between the head plate and substructure provides additional protection against footfall sound and penetrating moisture.
- The height of the post foot can be adjusted to up to 850 mm after assembly.
- Thanks to the height adjustment, manufacturing tolerances relating to the structure and subsequent settlement in the individual foundations can be balanced out.
- High tensile and compressive load capacities

NOTES

- The durability of the pedestals is ensured thanks to hot-dip galvanisation in accordance with DIN EN ISO 12944-2 (C3).

COMBINATION OPTIONS

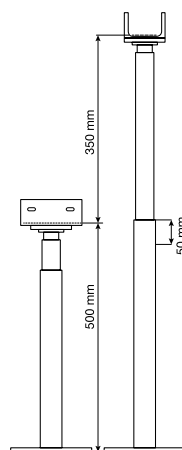
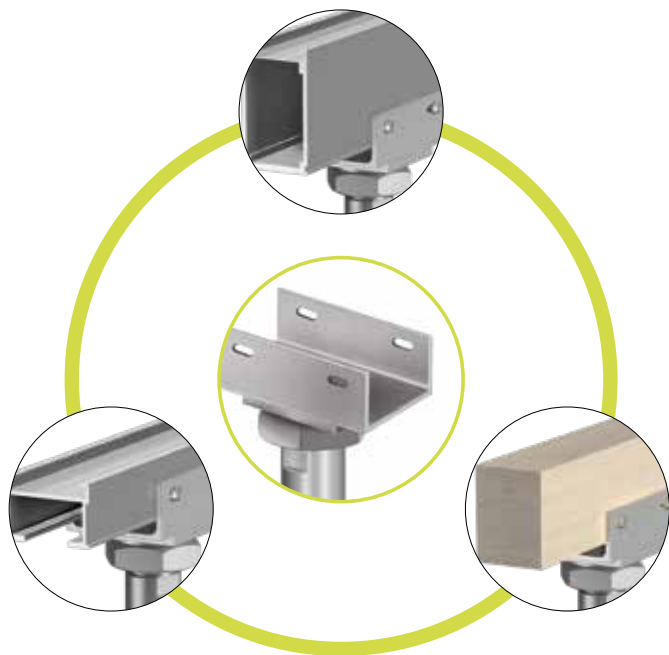

Suitable for this:
Rock concrete screw hexagonal
BIM A2 10,5 x 95 mm, Art. no.: 110355

BRIEF TECHNICAL DESCRIPTION

- Simple assembly with U-shaped head plate
- Can be combined with the HKP deck-support profile and the EVO aluminium system profile
- Min. timber cross section of 60 x 100 mm
- Additional timber protection thanks to EPDM for timber
- Hot-dip galvanised structural steel S235JR (ST37-2)
- Comes supplied with 4 BiGHTY drilling screw PH 4,8 x 25 mm
- Can be used in the usage classes 1, 2 and 3 in accordance with DIN EN 1995-1 -1
- The Robusto HV 500+350 allows constructive timber protection in accordance with the new DIN 68800-2.
- In addition to the vertical loads, the Robusto HV 500+350 can also transfer horizontal forces into the subsurface



The deck pedestal in combination with the HKP deck-support profile.



With the deck pedestal, it is possible to build accessible ramps and transitions.

Name	Art. no.	Height adjustment in assembled state	Min. post cross section	Dimensions of baseplate	Compressive loadbearing capacity	Tensile load-bearing capacity	Lateral force resistance ¹⁾	PU
Post feet on concrete		[mm]	[mm]	L x B x H [mm]	N _{c,d} [kN]	N _{t,d} [kN]	V _{R,d} [kN]	Stk.
Robusto HV 500+350	904661	500 - 850	60 x 100	160 x 100 x 8	21,2	9,2	-	2

Please note

The stated values are intended as planning aids. They are subject to typographical and printing errors. Projects must only be calculated by authorised persons.

1) The lateral force resistance must be overlaid with the compressive and tensile load in accordance with ETA 13-/0550 and can therefore lead to lower load-bearing capacities.





ALUMINIUM SYSTEM PROFILES

4









OVERVIEW OF EUROTEC ALUMINIUM SYSTEM PROFILES

					
	EVO	EVO SLIM	HKP	EVECO	EVO LIGHT
Application area	All-rounder, highly flexible, for any covering	Particularly suitable for low structural heights	To bridge high span widths	For grooved decking boards	Inexpensive alternative
Dimensions	40 x 60 x 2400 mm 40 x 60 x 4000 mm	20 x 60 x 2400 mm 20 x 60 x 4000 mm	100 x 60 x 4000 mm	24 x 39 x 2400 mm 24 x 39 x 4000 mm	32 x 34 x 4000 mm
Material	Aluminium	Aluminium	Aluminium	Aluminium	Aluminium
Hidden fastening	✓	✓	✓	✓	✓
Visible fastening	✓	✓	✓	—	✓

COMBINATION OPTIONS

 Deck gliders	✓	✓	✓	—	—
 Twin system clip	✓	✓	✓	—	—
 EVO Light system clip straight / bent	—	—	—	—	✓
 M-Clip	—	—	—	✓	—
 Profile drilling screw	✓	✓	✓	—	✓

Please note that not all profiles are available in black – this colour is available on request.

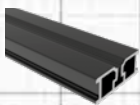

TERRA H15

Modular decking profile system

15 x 40 x 4000 mm

Aluminium



—

—

—

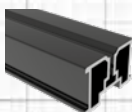

TERRA H24

Modular decking profile system

24 x 40 x 2000 mm
24 x 40 x 4000 mm

Aluminium



—

—

—

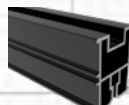

TERRA H50

Modular decking profile system

50 x 40 x 4000 mm

Aluminium



—

—

—

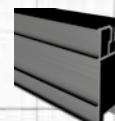

TERRA H85

Modular decking profile system

85 x 40 x 4000 mm

Aluminium



—

—

—





EVO ALUMINIUM SYSTEM PROFILE

THE ALL-ROUNDER IN OUR PROFILE RANGE

The EVO aluminium system profile is the **all-rounder** in our aluminium profile range. With this profile, using a **variety of wood types and stone coverings** is easy. The ideal cross section of the aluminium profile enables a variety of fastening options and allows **high span widths** to be achieved.

ADVANTAGES / PROPERTIES

- With drainage hole to avoid odours and moss growth
- In contrast to timber substructures, the profile is dimensionally stable and straight.
- It doesn't suffer from climate-related effects such as warping, cracks, etc. that naturally occur with timber.
- The special shape prevents the screws from shearing off.
- Allows both hidden and visible fastening.
- Compatible with the Eurotec Stone System

WITH DRAINAGE HOLES

to avoid odours and moss growth.



Art. no.	Dimensions [mm] ¹⁾	Material	PU
975621	40 x 60 x 2400	Aluminium	1
975610	40 x 60 x 4000	Aluminium	1
S975621	40 x 60 x 2400	Aluminium, black	1
S975610	40 x 60 x 4000	Aluminium, black	1

¹⁾ Height x width x Profile length

Please note that not all profiles are available in black – this colour is available on request.

COMBINATION OPTIONS



Use the aluminium concrete bracket (Art.-no.: 975661) for fixing to concrete.



Twin system clip



Profile drilling screw

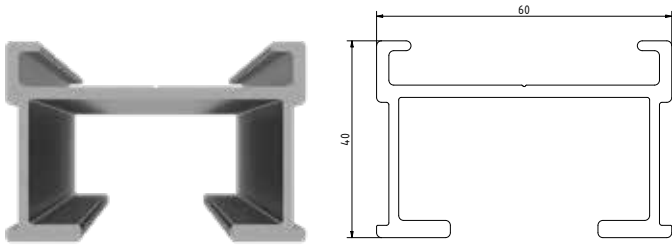

Cross-section values ^{b)}		
E-Modulus [N/mm ²]	W _y [mm ³]	I _y [mm ⁴]
70000	3438	70480

^{b)}W_y = section modulus; I_y = geometrical moment of inertia

SUITABLE FOR
PROFI- AND BASE-
LINE ADJUSTABLE
PEDESTALS



(Example:
Adjustable pedestal
PRO with L adapter)

Max. support spacing L [mm] for EVO aluminium system profile with adjustable pedestals^{a)}

Payload [kN/m ²]	BASE-Line adjustable pedestals, perm. F = 2,2 kN							
	Centre distance e [mm] between the profiles ^{b)}							
	300	350	400	450	500	550	600	800
2,0	1000	1000	900	800	750	600	600	450
4,0 ^{c)}	750	650	550	500	450	400	350	250
5,0 ^{d)}	650	550	450	400	350	350	300	-

Payload [kN/m ²]	Profi-Line adjustable pedestals, perm. F = 8,0 kN							
	Centre distance e [mm] between the profiles							
	300	350	400	450	500	550	600	800
2,0	1000	1000	1000	950	900	850	850	750
3,0 ^{c)}	1000	950	900	850	850	800	800	700
4,0 ^{c)}	900	850	850	800	750	750	700	650
5,0 ^{d)}	850	800	800	750	700	700	650	600

^{a)}Indication of max. span at which the profile's deflection does not exceed L/300. Average board thickness of 25 mm with a specific weight of 7 kN/m³ (larch, pine, Douglas fir).

^{b)}E. g.: spacing between profiles = 550 mm; payload = 2,0 kN/m² → max. span of the profile = 600 mm.

^{c)}Payloads according to DIN EN 1991-1; roof terraces = 4 kN/m², deck for public use = 5 kN/m².

^{d)}Load capacity according to SIA 261 for balconies and roof terraces private use = 3 kN/m²



ACCESSORIES EVO ALUMINIUM SYSTEM PROFILE

EVO aluminium system profile connector



Art. no.	Dimensions [mm] ¹⁾	Material	PU*
975611	24 x 200 x 50	Aluminium	10

¹⁾Height x length x width

*Incl. 4 drilling screws per connector

NOTE

The profile butt joint is only to be positioned directly above a post or support.

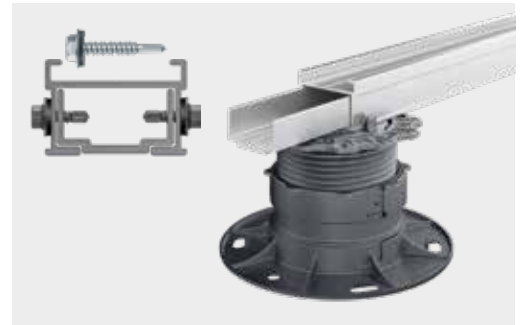

Example of fixing an EVO aluminium profile connector

EVO corner connector

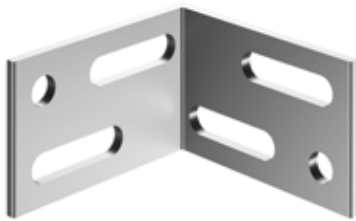

Art. no.	Dimensions [mm] ¹⁾	Material	PU
975612-10	40 x 40 x 25	Aluminium	10*
975612-200	40 x 40 x 25	Aluminium	200**

¹⁾Height x length x width

*Incl. 40 screws, **Incl. 800 screws



Example of application EVO corner connector

EVO wall-connection bracket



Art. no.	Dimensions [mm]	Material	PU*
975627	100 x 30	Aluminium	10

*Supplied with 1 drilling screw per wall-connection bracket for attachment to the EVO aluminium system profile.

The EVO wall-connection bracket is ideal for use as a position anchor for deck substructures made of aluminium. The bracket is used to fasten the EVO aluminium system profile directly to the wall. Two EVO wall-connection brackets are needed per aluminium profile. The slots in the wall-connection bracket allow the substructure to expand without problems and therefore prevent it from shifting out of position.

PROPERTIES

- Slot diameter: 6 mm or 7 mm
- Slot length: 15 mm
- Material thickness: 3 mm



Example of application EVO wall-connection bracket

LOAD BRACKET

For securing terraces

Especially when using **lightweight terrace decking** like WPC boards, **bending and warping** can occur due to waterlogging or heat buildup. With the help of our load bracket, additional loads in the form of e. g. heavy stone slabs can be added within the **substructure to counteract potential warping**.

Load bracket



Art. no.	Dimensions [mm] ¹⁾	Material	PU ²⁾
945061	40 x 60 x 40	Aluminium	10

¹⁾Height x width x depth

²⁾Each Load bracket comes with two 4.8 x 25 mm BiGHTY drilling screws (art. no. 945886) for fastening to the profiles

ADVANTAGES/PROPERTIES

- Prevents potential deformation or warping of the terrace
- Helps to secure the terrace's position
- Compatible with our EVO system profile and our HKP support system

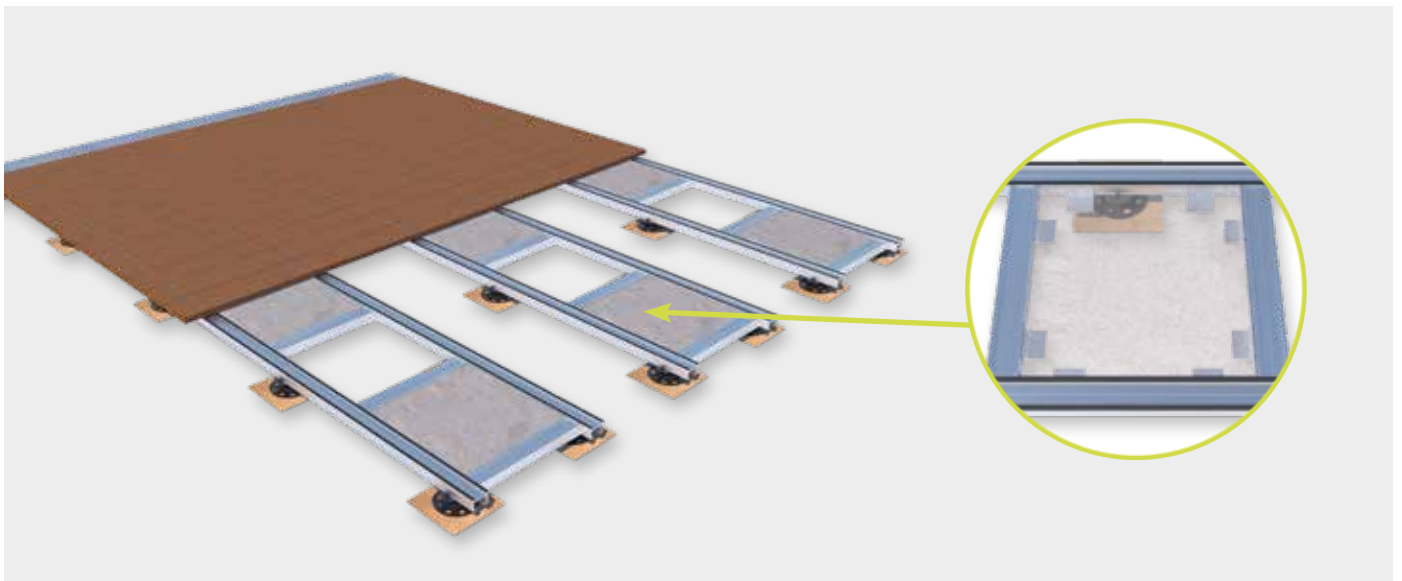

Wind suction securing in timber terraces with concrete slabs and load brackets.

TAKE WIND SUCTION INTO ACCOUNT

To build a roof terrace, it is vital to take wind forces into account when planning the terrace design. Wind forces have a varying impact on the terrace, depending on the building height, shape and location, and they determine the amount of wind suction that occurs. Accordingly, the terrace needs to be secured against wind suction to prevent it from lifting off or sliding.

i WIND SUCTION

Wind suction is a wind load arising from the flow of wind. It acts on surfaces, which means that all external parts of a building need to be taken into account. Wind suction occurs as the result of pressure differences between the air blowing past and the air inside or underneath parts of the building. As the pressure of the air that blows past is lower than the air of the building elements, air is pulled out of the building parts. The air flowing out of the building parts exerts pressure on these parts, so failing to take wind suction into account from the outset can result in damage being caused.

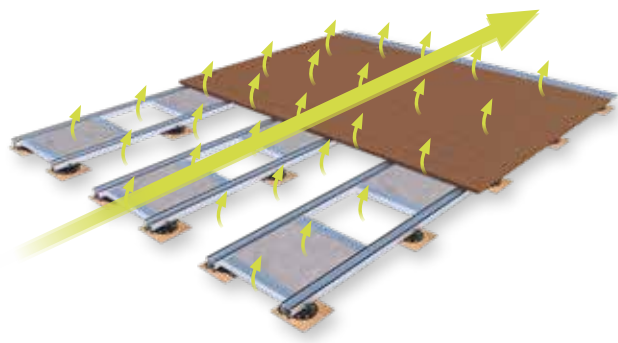

All roof terraces are exposed to different forces and conditions. The particular loads therefore need to be taken into account in every project. **“Eurocode 1: Actions on structures” to DIN EN 1991-1-4** contains helpful reference values that can be used as a guide. The table below provides an overview of the potential impact forces.

CREATE A TICKET
NOW SO WE
CAN HELP YOU!



TECHNICAL VALUES TO DIN EN 1991-1-4/NA

Wind zone		Simplified gust velocity for structures up to 25 m in height to DIN EN 1991-1-4/NA		
		Velocity pressure q in kN/m^2 for building height h within the boundaries of		
		$h \leq 10 \text{ m}$	$10 \text{ m} \leq h \leq 18 \text{ m}$	$18 \text{ m} \leq h \leq 25 \text{ m}$
1	Inland	0,50	0,65	0,75
2	Inland	0,65	0,80	0,90
	Baltic Sea coasts and islands	0,85	1,00	1,10
3	Inland	0,80	0,95	1,10
	North Sea and Baltic Sea coasts	1,05	1,20	1,30
4	Inland	0,95	1,15	1,30
	North Sea and Baltic Sea coasts and Baltic Sea islands	1,25	1,40	1,55
	Baltic Sea islands	1,40	-	-

**LOAD BRACKETS
FOR SECURING /
BALLASTING**



Wetness and heat differences can cause the terrace to warp in WPC decking boards made from plastic. Particularly in structures located on level surfaces (e. g. roof terraces) with a lightweight covering, there is a risk of wind suction, causing the terrace to slide out of position. To prevent this, it is recommended to weigh down the substructure using the load brackets and additional concrete slabs laid on the connectors.

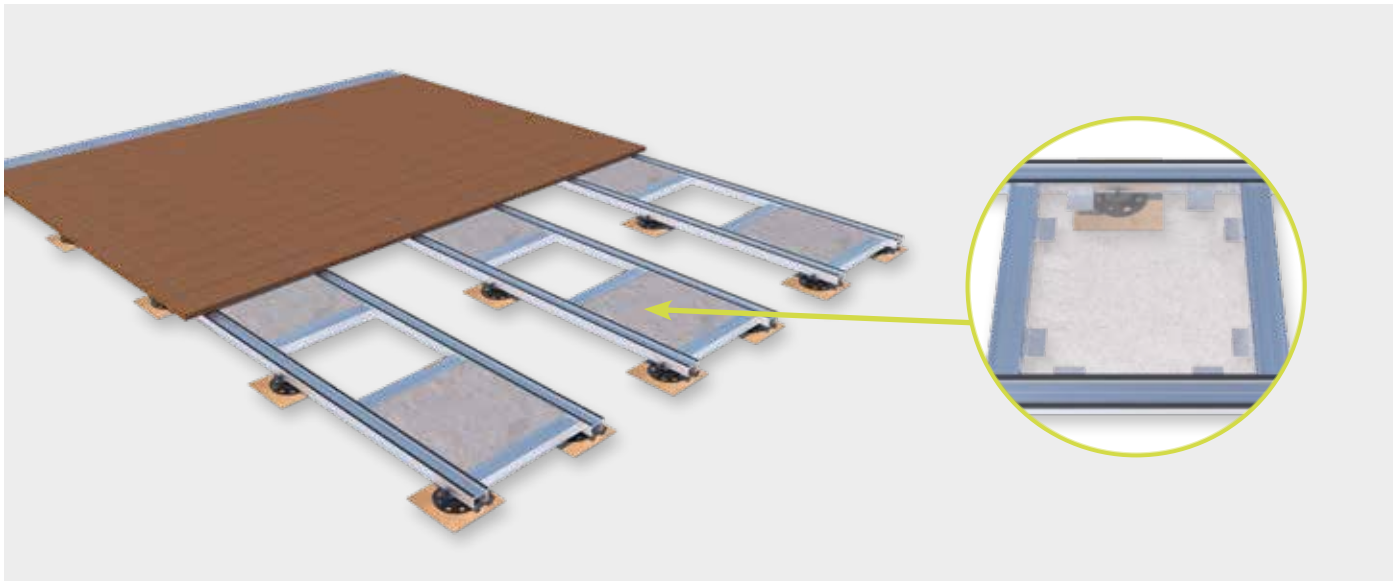

Wind suction securing in timber terraces with concrete slabs and load brackets.

To give a terrace structure optimum protection from environment influences such as strong wind, the structure should be sufficiently weighed down. To achieve this, concrete slabs are installed in the substructure with our load brackets. The number of slabs needed varies depending on the location of the terrace. Terraces protected from the wind by buildings require fewer slabs than a roof terrace on a multi-storey building, for example. Along the edges in particular, sufficient additional slabs should be installed to ensure that undesired warpage of the structure caused by external influences is minimised.

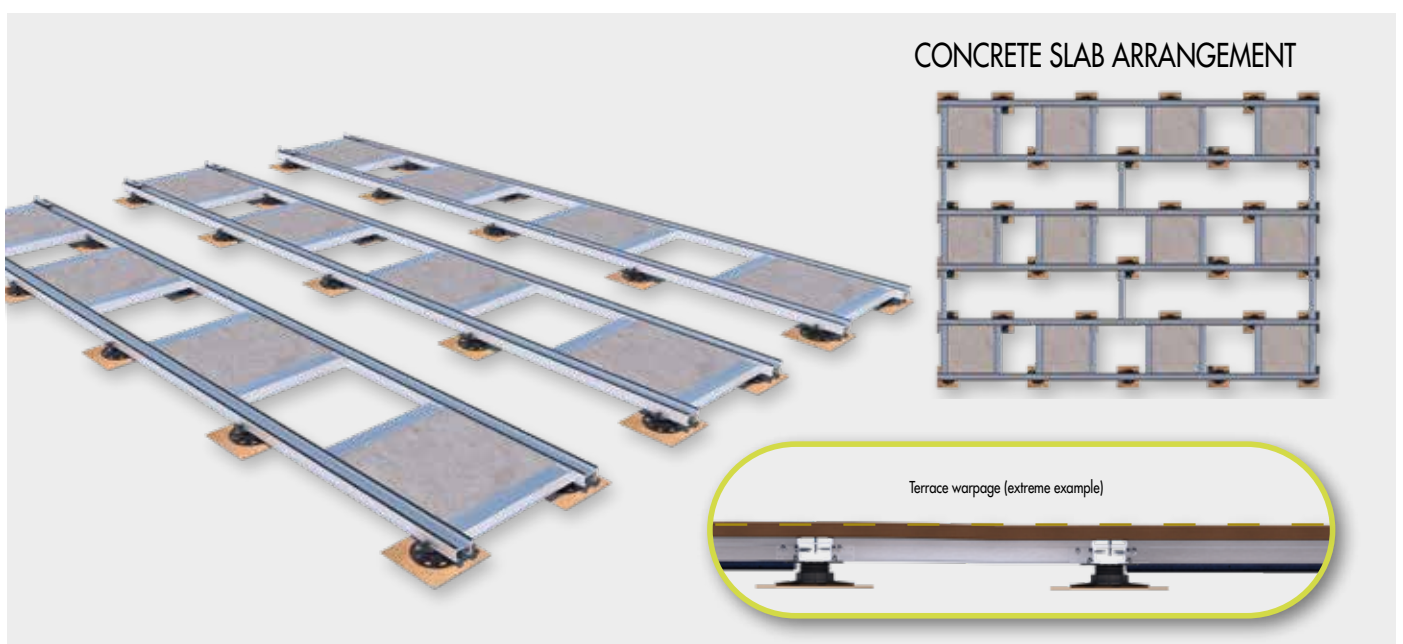

Securing against warpage caused by environmental influences

EVOdry WATER DRAINAGE SYSTEM

For creating a sealed surface without much effort

The EVOdry water drainage system by Eurotec is a water-draining laying system for balconies and terraces. For terraces in particular, moisture quickly gets to the unprotected substructure and usually destroys it more quickly than the decking. An unstoppable process of decay begins. The EVOdry water drainage system helps you prevent this from the start. The installation system seals completely at the base, which furthermore protects the substructure from dirt and plant growth. This increases the lifespan of the terrace many times over.

EVOdry rail



Art. no.	Name	Dimensions [mm] ¹⁾	Material	PU*
975681	EVOdry rail	14 x 45 x 4000	Aluminium, black	1
100547*	EVOdry sealing tape	50000	TPE-S, black	1

¹⁾ Height x width x Profile length

The EVOdry sealing tape (100547) is not included in the scope of delivery.

ADVANTAGES

- Targeted drainage of water
- Protection of the substructure against moisture, dirt and plant growth
- Extended substructure lifespan

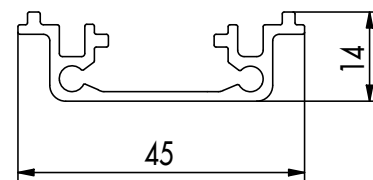

EVOdry holder



Art. no.	Dimensions [mm] ¹⁾	Material	PU
975683	23 x 50 x 115	Plastic, black	10

¹⁾ Height x width x length

The EVOdry clip affixes the EVOdry rail on the spot, so that it does not slip.

TECHNICAL DRAWING: CONSTRUCTION

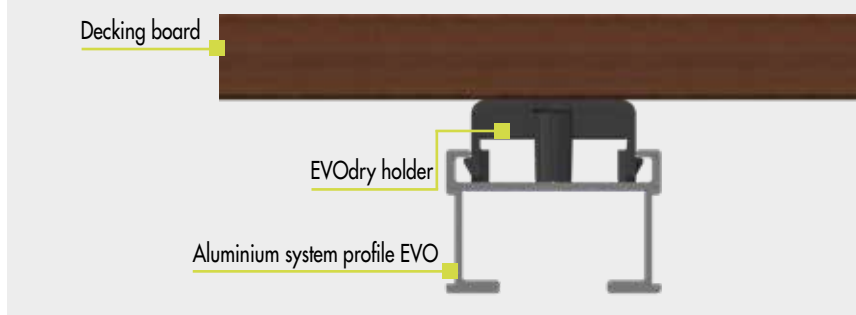

EVOdry closure



Art. no.	Dimensions [mm] ¹⁾	Material	Material thickness [mm]	PU*
975682	12 x 35	Aluminium	1,5	10

¹⁾ Height x width

*Screws are included

The EVOdry closure can be fitted on one side and ensures that the water is directed into a gutter, for example.

EVOdry clip straight

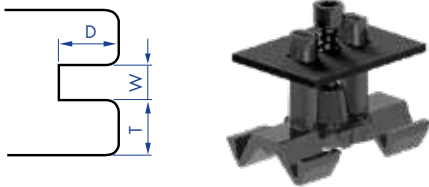

Art. no.	Name	Dimensions [mm] ¹⁾	Material	PU
975693	EVOdry clip, straight	26,5 x 22 x 34	Plastic/A2, black	100

¹⁾Height x width x length

The EVOdry clips are suitable for hidden fastening.

EVOdry clip straight is suitable for boards with the following groove geometry

Groove depth, D:	Groove width, W:	Groove wall thickness, T:
≥ 7,5 mm	≥ 2,0 mm	≥ 7,0 – 10,0 mm

Where applicable, the manufacturer / timber supplier must establish whether the timber type is suitable.

EVOdry clip bent

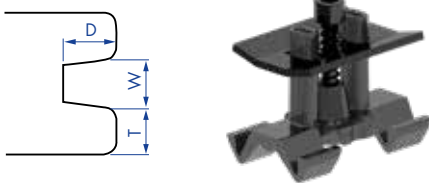

Art. no.	Name	Dimensions [mm] ¹⁾	Material	PU
975696	EVOdry clip, bent	26,5 x 21 x 34	Plastic/A2, black	100

¹⁾Height x width x length

The EVOdry clips are suitable for hidden fastening.

EVOdry clip bent is suitable for boards with the following groove geometry

Groove depth, D:	Groove width, W:	Groove wall thickness, T:
≥ 7,5 mm	≥ 4,0 mm	≥ 7,0 – 10,0 mm

Where applicable, the manufacturer / timber supplier must establish whether the timber type is suitable.

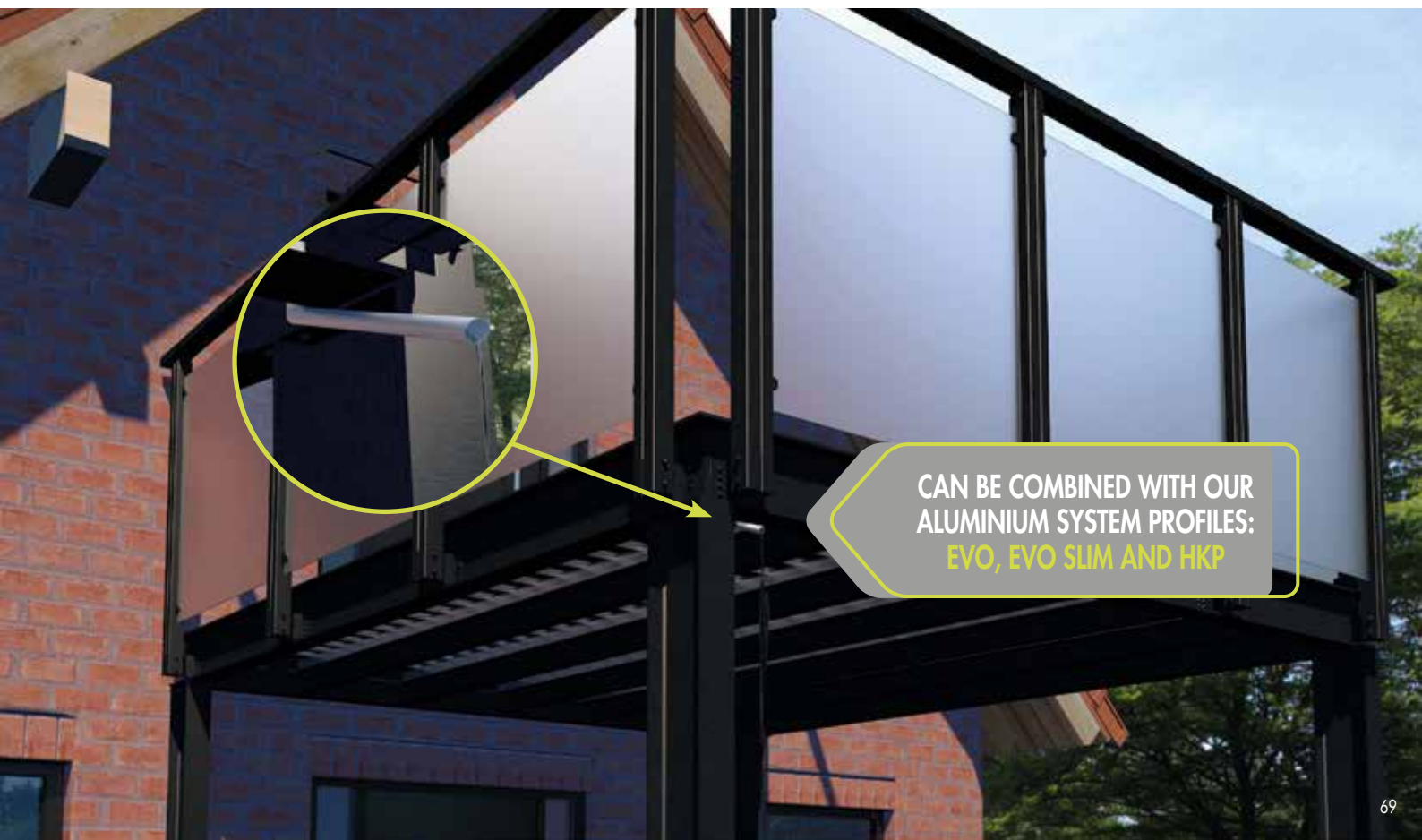

CAN BE COMBINED WITH OUR ALUMINIUM SYSTEM PROFILES:
EVO, EVO SLIM AND HKP

SECURING THE EVODRY WATER DRAINAGE SYSTEM – VISIBLE

1 Push the EVOdry holder into the rail until they click in.



2 Distribute EVOdry holder evenly



3 Insert EVOdry rails into the EVOdry holder.



4 Lay the floorboards, move the rails centrally into the joint and screw the floorboards through the EVOdry holder. If you have a floorboard with a height of 25 mm, fasten it with a profile drilling screw (length 61 mm).

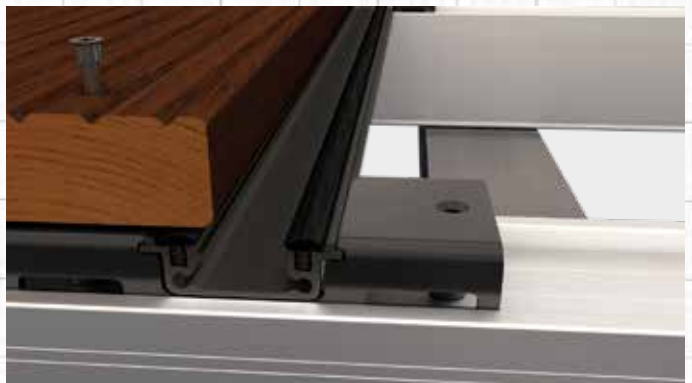

5 Maintain the clearance between the joints and lay the next floorboard.



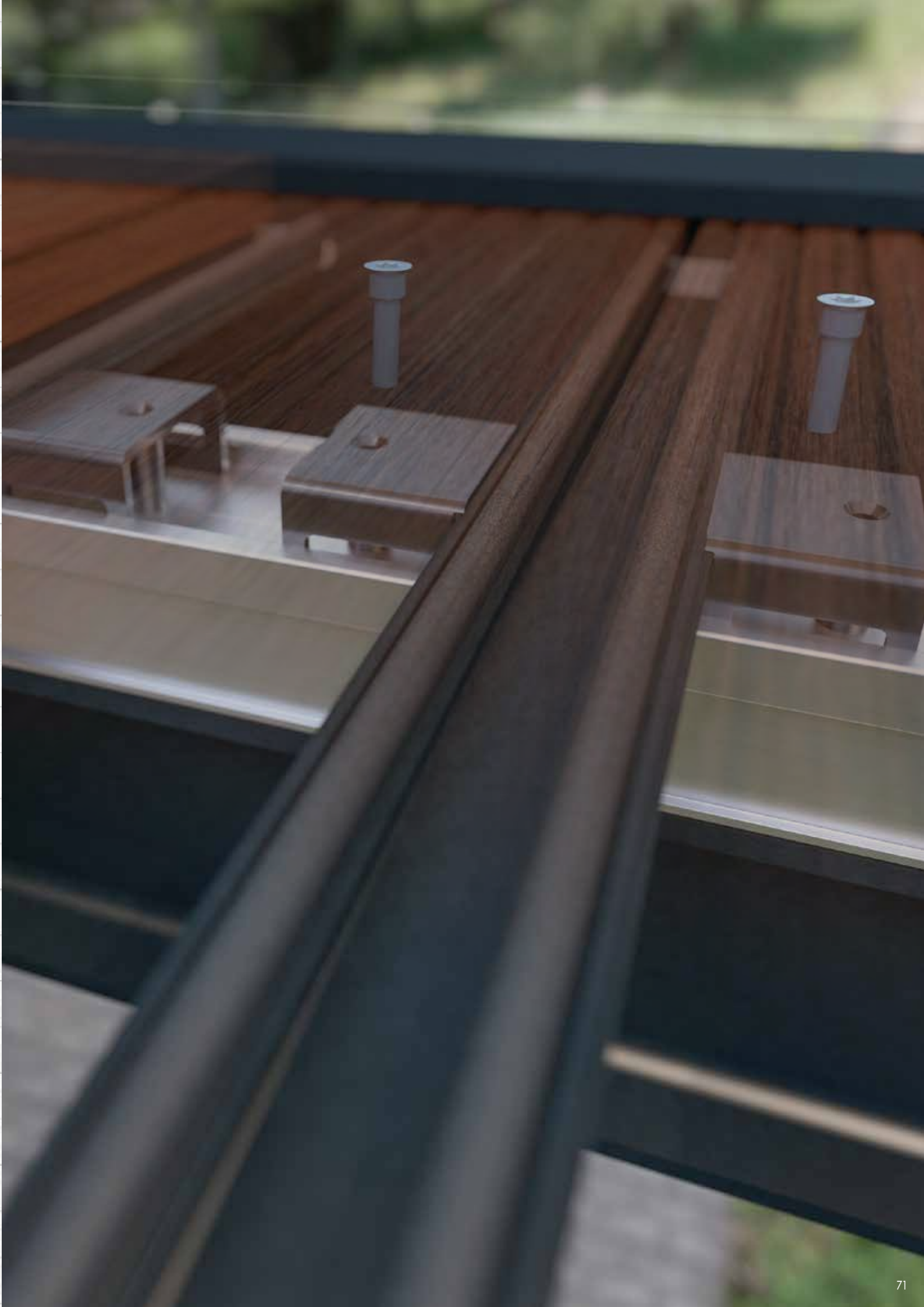

SECURING THE EVOdry WATER DRAINAGE SYSTEM – INVISIBLE

1 Push the EVOdry holder into the rail until they click in.



2 Distribute EVOdry holder evenly.

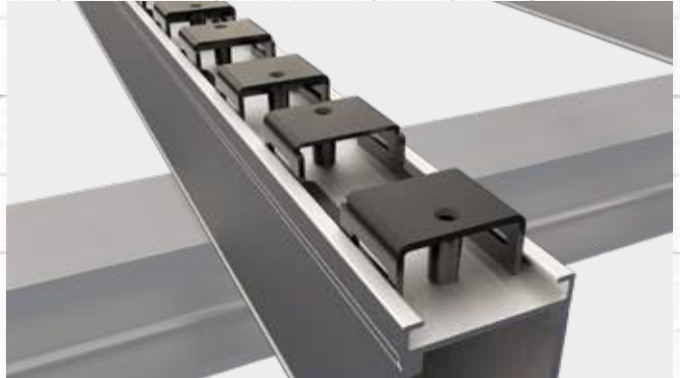

3 Insert EVOdry rails into the EVOdry holder.



4 Push the EVOdry clip into the EVOdry rail until it clicks in and use it only every 30 – 40 cm.



5 Insert the EVOdry rail with the EVOdry clips into the floorboard and affix it with a profile drilling screw (length 41 mm).

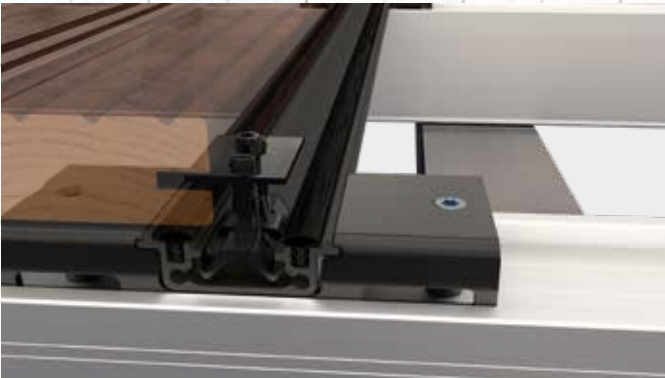

6 Insert the second floorboard into the retaining plate of the EVOdry clip and fasten it with the screw of the EVOdry clip.

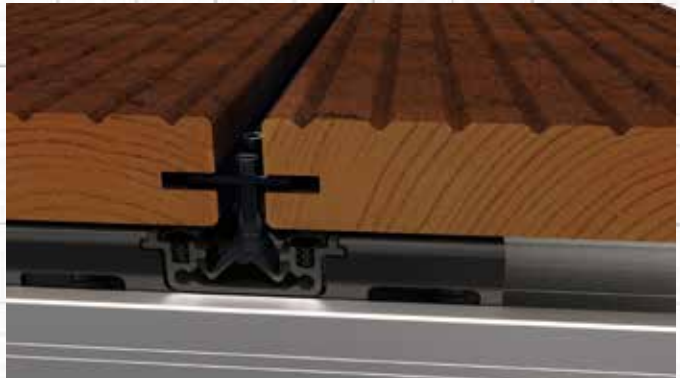

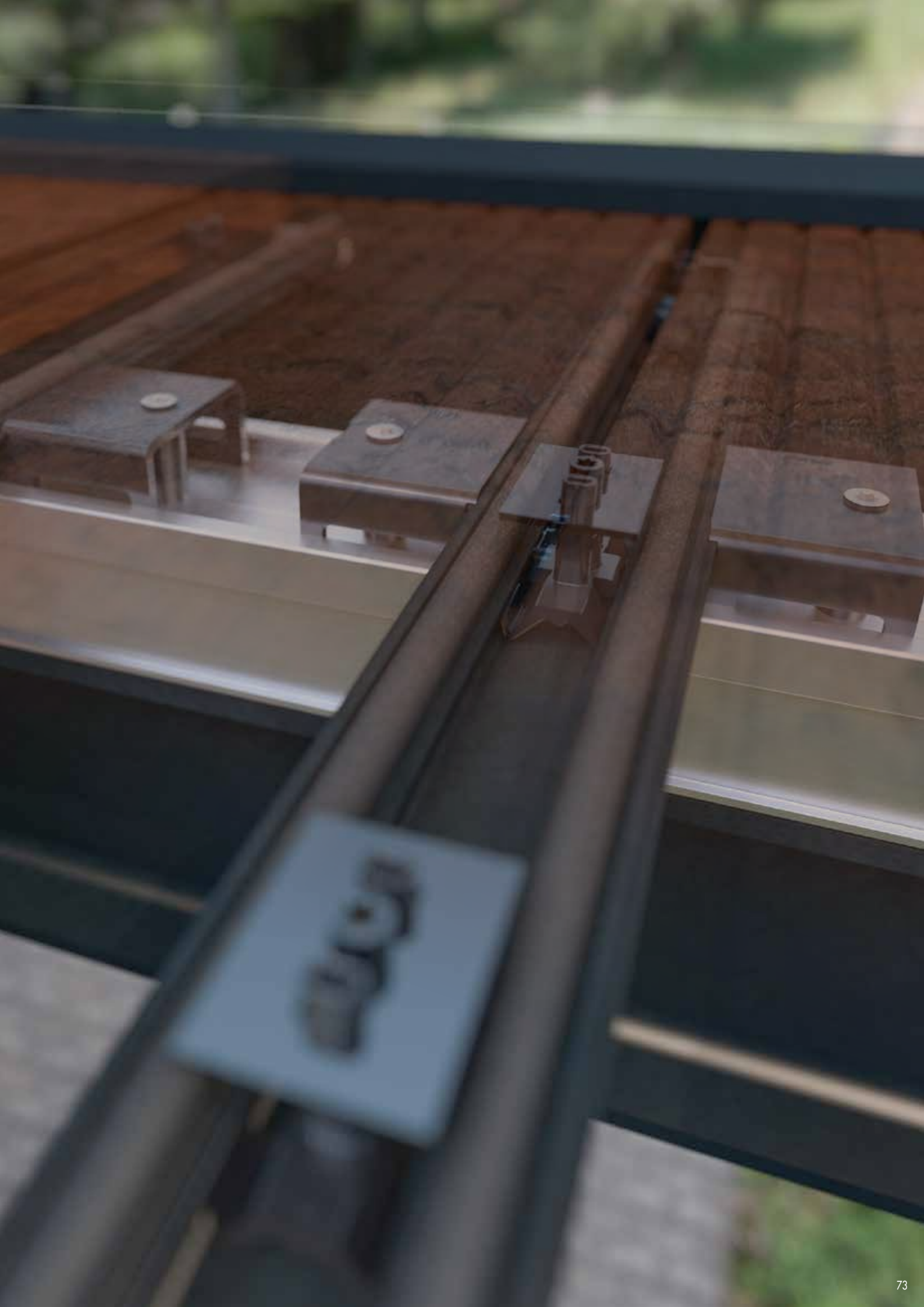

100100

EVO ALUMINIUM SYSTEM PROFILE MODULAR SYSTEM – TIMBER DECK

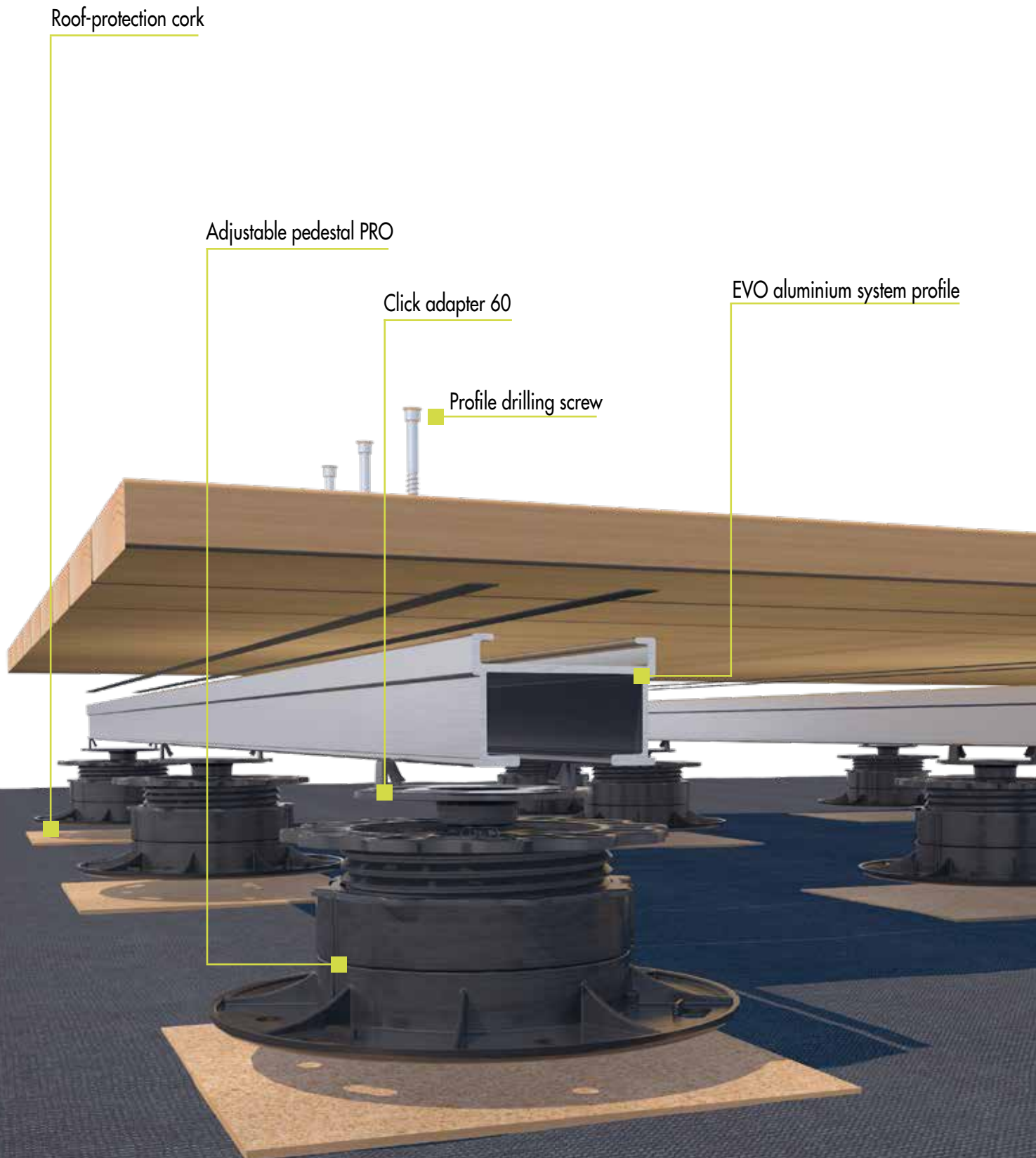

EVO ALUMINIUM SYSTEM PROFILE MODULAR SYSTEM – STONE PATIO

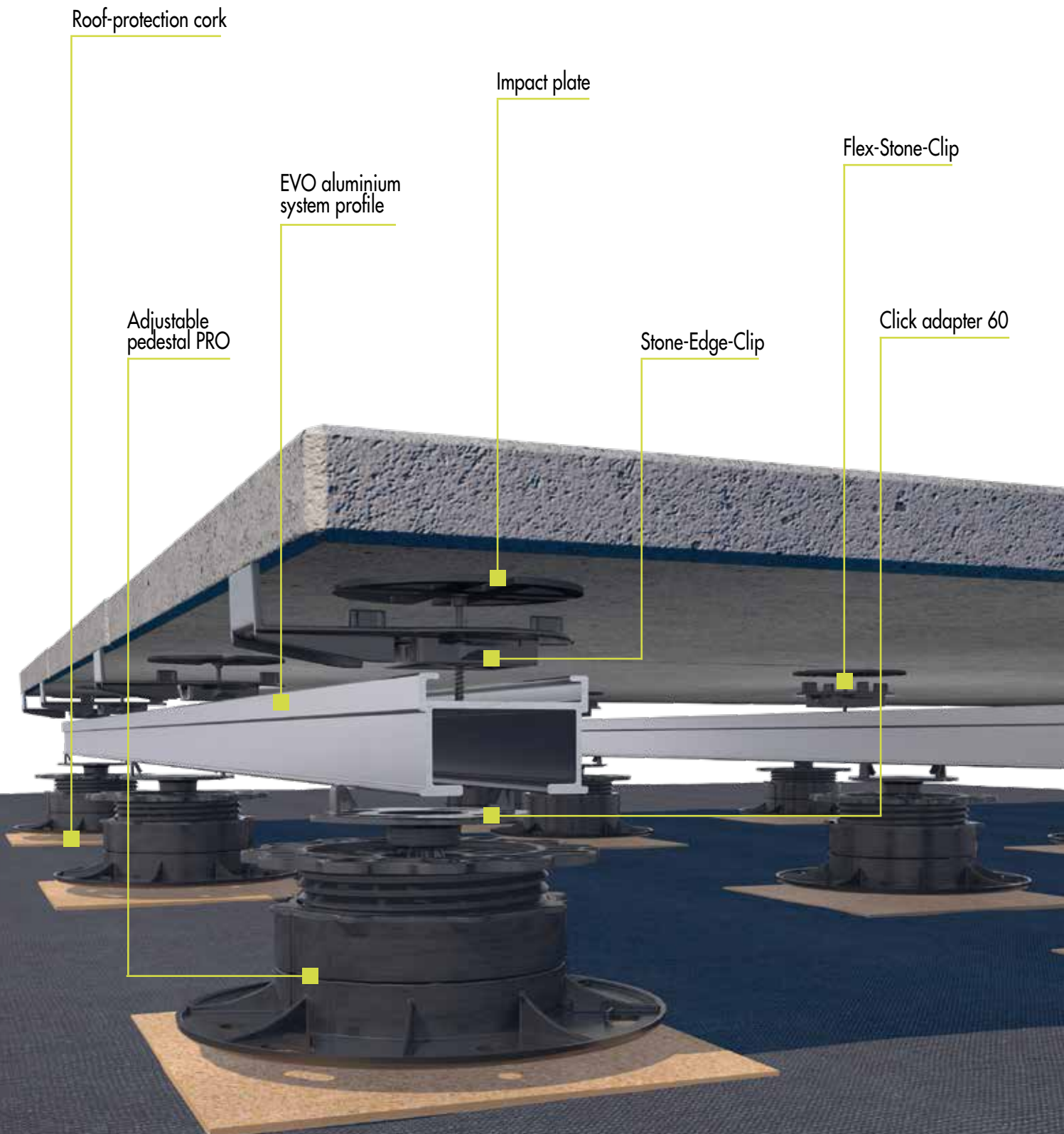



EUROTEC STONE-SYSTEM

MULTIFUNCTIONAL INSTALLATION SYSTEM

Numerous possibilities! Suitable for all common deck coverings.

The **multifunctional installation system** Stone System from Eurotec minimises the effort involved in constructing a patio. One unique practical feature of this system is that it can be combined with **various deck coverings**. You simply need a load-bearing foundation, the **Stone System** from Eurotec, and the desired deck covering.

ADVANTAGES

- Exceptionally economical
- Time-saving and straightforward installation
- Stone slabs can be combined with timber or WPC boards, for example
- Precise joint pattern
- Long-lasting
- Certified, high load-bearing capacity



For more information about the Stone system, please watch the application video on our YouTube channel

or download the Stone System brochure:
www.eurotec.team/en/catalogues

COMBINATION OPTIONS

Stone-Edge-Clip



Flex-Stone-Clip





ACCESSORIES FOR THE MULTIFUNCTIONAL STONE SYSTEM



Flex-Stone-Clip



Art. no.	Joint spacer dimensions [mm] ⁽¹⁾	PU*
975602	8 x 14 x 4	200

⁽¹⁾Height x length x width

*For fastening, we recommend using Aluminium profile drilling screw (645026). These are not included.

For clicking onto the EVO aluminium system profile within the paving.

Note

The flexibility of the Flex-Stone-Clip allows it to compensate for manufacturing tolerances of up to 2 mm in stone slabs.



Example of application Flex-Stone-Clip

Stone-Edge-Clip



Art. no.	Joint spacer dimensions [mm] ⁽¹⁾	PU*
975603	8 x 14 x 4	50

⁽¹⁾Height x length x width

*Comes supplied with one screw per clip.

For clicking onto the EVO aluminium system profile at the edges.

To prevent individual stone slabs from slipping, the stone edge clips are to be screwed to the aluminium substructure in the edge area. The clips have a screw channel in the middle for this purpose.



Example of application Stone-Edge-Clip

Aluminium Profile drilling screw



Art. no.	Dimensions [mm]	Drive	PU
645026	4,2 x 35	TX15 •	100

RECOMMENDED SUPPORT FOR STONE COVERINGS

Support on aluminium system profile

If a stone terrace is set up with insufficient support points, the slabs may break when exposed to load. For this reason, the size of the stone slabs used determines the combination of longitudinal and cross bracing in the form of aluminium system profiles and the application of Flex Stone Clips and Stone Edge Clips. The following images depict various example sizes with the corresponding required support and can be used as a guide for designing the aluminium substructure correctly.



60 x 60 cm

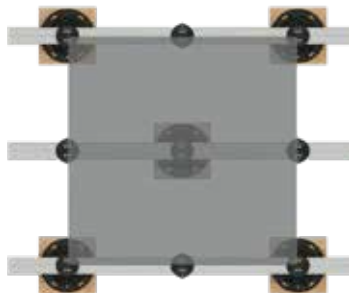

80 x 80 cm

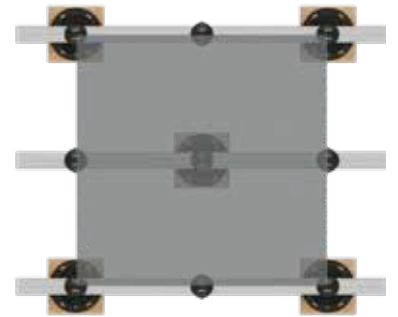

90 x 90 cm



80 x 40 cm



120 x 40 cm



120 x 60 cm

Important

Observe the manufacturer's instructions for supporting the stone slabs! Using our system does not release planners / processors from their duty to find out about the manufacturer's specifications for other products (installed together with our system).



90 x 60 cm

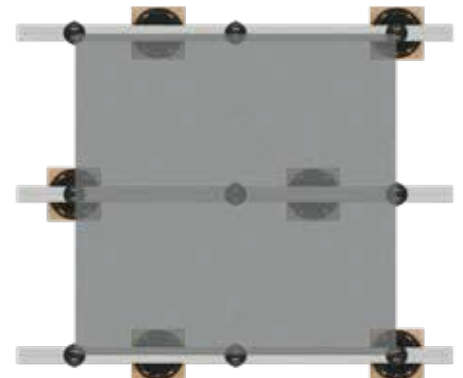

120 x 120 cm

ACCESSORIES FOR SUPPORTING THE TERRACE COVERING

Cross bracing EVO



Art. no.	Name	Material	Dimensions [mm] ^{o)}	PU
975666	Cross bracing EVO	Aluminium	60 x 40 x 340	1

^{o)}Height x width x profile length

Our cross bracing is the perfect complement to our aluminium profiles. The pre-mounted brackets make installation even easier.

ADVANTAGES

- Simple, time-saving assembly
- Faster completion of the terraces
- The prefabricated cross bracing prevents the costly process of cutting the profiles on the construction site.
- Clean prefabrication ensures professional assembly.

INSTRUCTIONS FOR USE

The cross bracings can only be used with a centre distance of 40 mm.

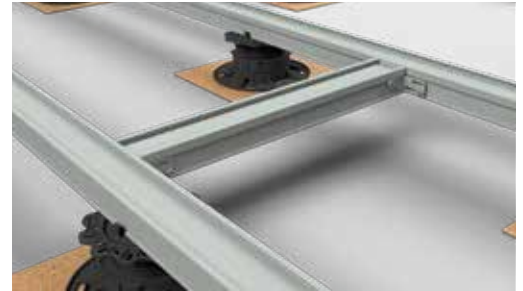

Example of application cross bracing EVO



Substructure with adjustable pedestals PRO, EVO aluminium system profile and cross bracings EVO

Support Clip Set

To support the terrace covering

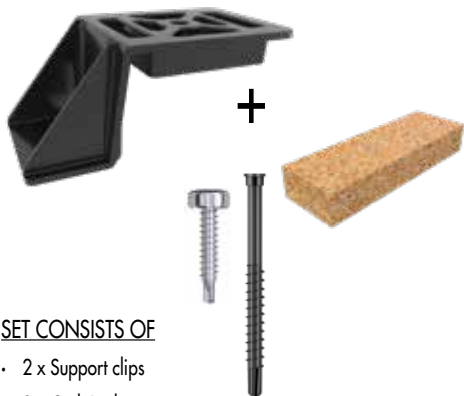

SET CONSISTS OF

- 2 x Support clips
- 2 x Cork Pads
- 2 x BiGHTY drilling screw 4,8 x 25 mm
- 2 x Aluminium profile drilling screw 4,2 x 35 mm

Art. no.	Dimensions [mm] ¹⁾	Material	PU
945970	40 x 93,7 x 50	Polypropylen-Copolymer (PP-C)	2

¹⁾Height x depth x width

The set is used to support the terrace covering, is a flexible and high-quality alternative to conventional support measures, thereby preventing the stone slab from breaking. Can be combined with the EVO Light aluminium system profile as cross bracing.

ADVANTAGES / PROPERTIES

- Prevents stone slabs from breaking quickly
- Foot fall noise insulation by using cork pads
- Possible to adjust to the standard centre-to-centre spacing of the substructure
- Adjusting feet as well as EVO aluminium system profiles can both be done away with thanks to the support clip
- Possible to mount the clips using a click system or fastening screws

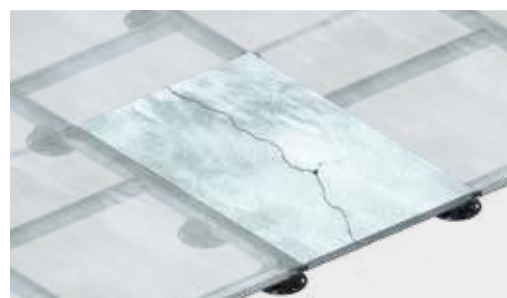

Increased risk of breaking individual slabs due to a lack of support profile.

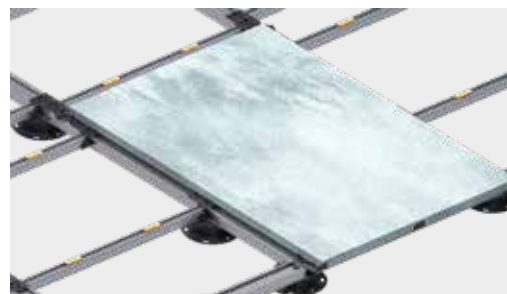

Increased risk of breaking after mounting the support clip set.

USING THE SUPPORT CLIP SET

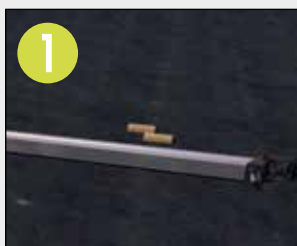

1 Cut EVO Light to the desired length. Insert the EVO Light rail into the plastic clips and screw from below with the enclosed BiGhty screws.

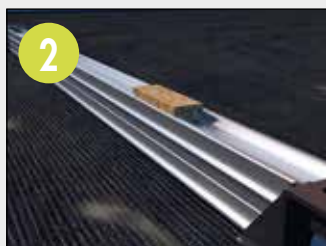

2 Remove the protective film from the cork pad and adhere the pad in the rail.



3 Distribute the rails evenly to provide optimum support for the stone slabs. Fasten with the enclosed aluminium profile drilling screw Ø 4,2 x 35.



4 Apply slabs – done!

ACCESSORIES FOR BUILDING STEPS / RAMPS



90° EVO joint



Art. no.	Dimensions [mm] ^{a)}	Material	PU*
975623	23,5 x 84,0 x 100	Zinc die-cast	4

^{a)}Height x length x width

*For fastening, we recommend using Biglity PH drilling screws (954068). These are not included in the product.

ADVANTAGES / PROPERTIES

- For connecting the aluminium system profiles with each other
- Freely rotating joint
- For angles of up to 90°
- Individual positioning in the EVO system profile
- Rivet is made of stainless steel A2 according to DIN6791



Example of application 90° EVO joint

180° EVO joint



Art. no.	Dimensions [mm] ^{a)}	Material	PU*
975624	23,5 x 131,5 x 49,25	Zinc die-cast	4

^{a)}Height x length x width

*For fastening, we recommend using Biglity PH drilling screws (954068). These are not included in the product.

ADVANTAGES / PROPERTIES

- For connecting the aluminium system profiles with each other
- Freely rotating joint
- For angles of up to 180°
- Individual positioning in the EVO system profile
- Rivet is made of stainless steel A2 according to DIN6791



Example of application 180° EVO joint

EVO position anchor



Art. no.	Dimensions [mm] ^{a)}	Thickness [mm]	Material	PU*
975622	27,5 x 49 x 23,5	2,5	Zinc die-cast	10

^{a)}Height x length x width

*Comes supplied with 30 screws.

The EVO position anchor provides a simple and straightforward solution for joining Eurotec EVO aluminium system profiles. Thanks to the EVO position anchor, the aluminium profiles can be joined at an angle of between 30° and 90°.

ADVANTAGES

- Versatile applications
- Corrosion-resistant
- Easy to use

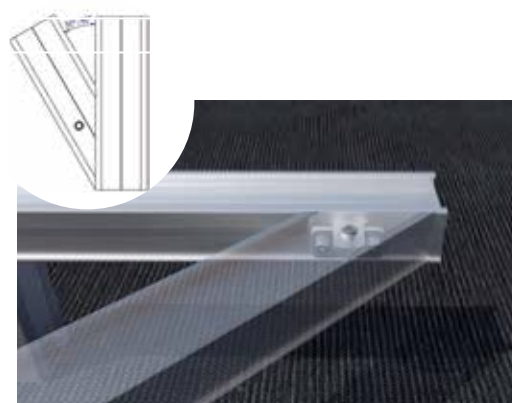

Example of application EVO position anchor

90° profile connector



Art. no.	Dimensions [mm]	Thickness [mm]	Material	PU*
944912	52 x 52 x 18,5	2,5	Hot-dip galvanised steel	10

*Comes supplied with screws.

The 90° profile connector is used to create a 90° angle in connection with the EVO, EVO Light or Eveco aluminium system profiles. It is placed in the groove of the profiles, thereby preventing slipping during the screwing process. In contrast to other angles, the 90° profile connector can simply be screwed onto the outside of the profile and does not have to be mounted on the inside. In conjunction with the Eveco corner connector, it provides safety and additional support.

CAN BE COMBINED WITH OUR
ALUMINIUM SYSTEM PROFILES:
EVO, EVO LIGHT AND EVECO

ADVANTAGES

- Simple and time-saving installation compared to alternative fastening options, as the 90° profile connector can be screwed onto the profile from the outside.
- Versatile applications
- Corrosion-resistant



90° profile connector for connecting two EVO aluminium system profiles

ACCESSORIES FOR BUILDING A ROUND TERRACE/VERANDA

EVO hinge connector



Art. no.	Product description	Dimensions [mm] ¹⁾	Material	PU ²⁾
975589	TERRA Location security	19 x 12,45 x 131	S235 hot-dip galvanised	4
975750	EVO hinge connector	25 x 12,45 x 131	S235 hot-dip galvanised	4

¹⁾ Height x width x length

²⁾ For fastening, we recommend using Bighty PH 954090-50. These are not included in the product.

The EVO hinge connector is the universal connection element for connecting profiles at an angle other than 90°. It is easily screwed to the profiles on the side and can then be adjusted flexibly to suit any individual angle.

ADVANTAGES

- Versatile applications
- Simple handling for connection greater than / less than 90°
- Polygonal geometries can easily be constructed
- For structures that are walked on continuously, we recommend two position anchors at each point of intersection.



Example of application EVO hinge connector

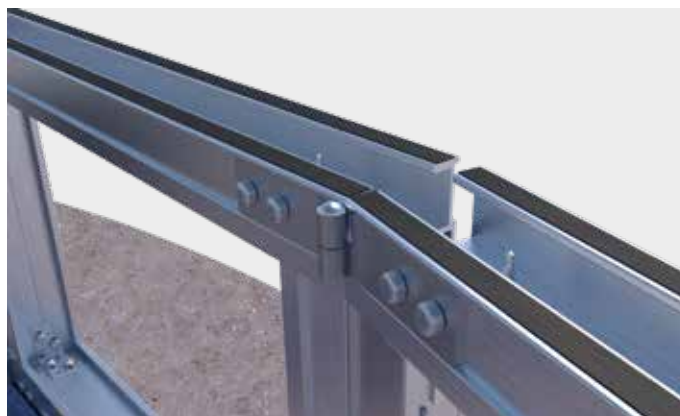

With the EVO hinge connector, profiles can easily be joined together in a wide range of angles.

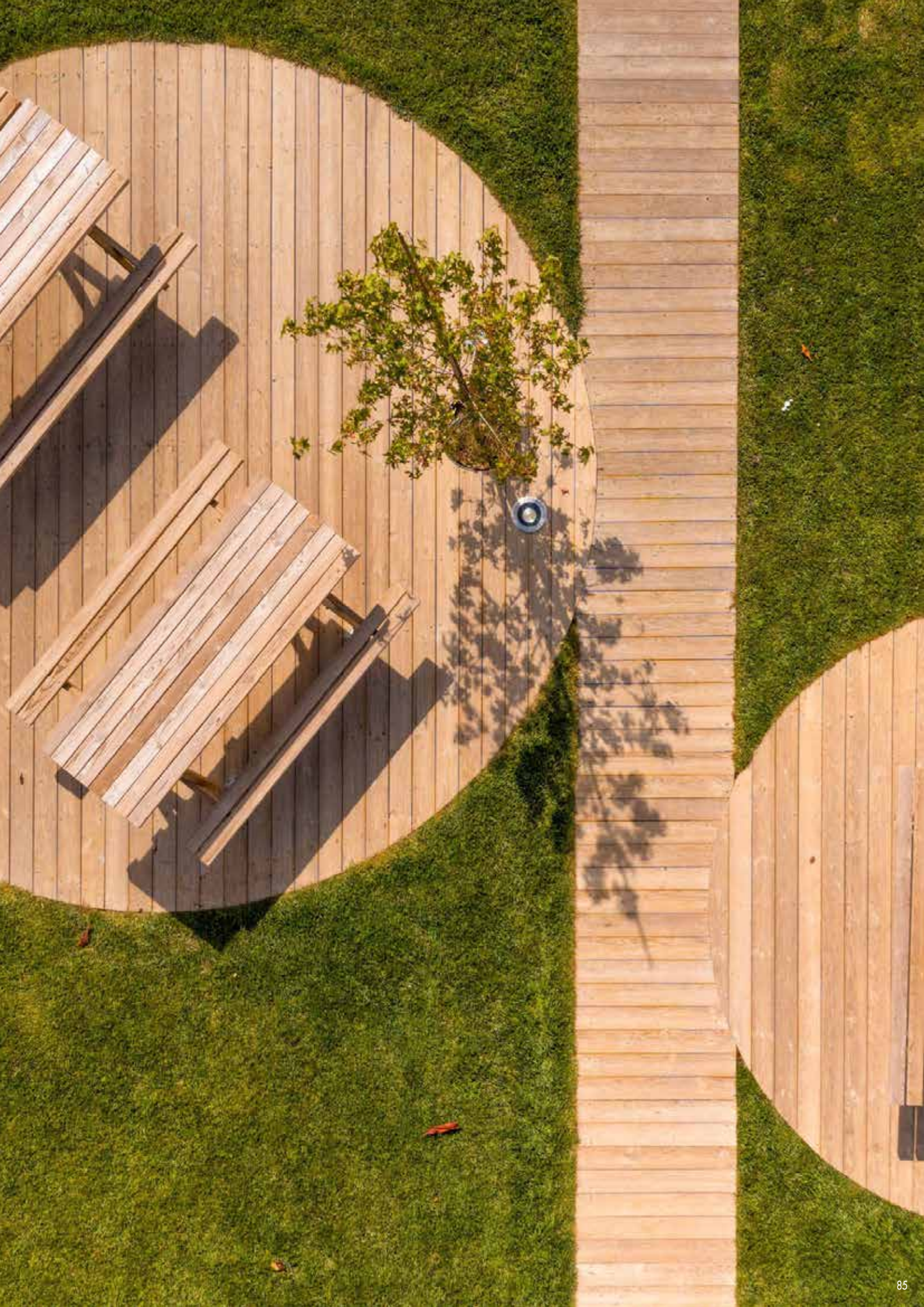



TERRA

ALUMINIUM SYSTEM PROFILE

Eurotec's **TERRA aluminum system profiles** are a modular system for constructing aluminum deck substructures. The modular system includes everything needed for deck construction and can be used in combination with our Profi-Line adjustable pedestal and BASE-Line.

The TERRA system profiles are used as aluminum substructure profiles for deck construction. Compatible with the various versions of the aluminum system profiles, the modular system also includes angle and profile connectors as well as flexible joints for installation at 90° and 180° rotation angles. In this way, the modular system can be used to create a stable and long-lasting deck substructure.

NOTE

If the profiles are used in combination with products for hidden deck board fastening, they should be oriented with the screw channel facing upward.

If you wish to mount the deck boards directly to the profiles using screws, turn the profile so that the underside faces upward. This way, the special geometry of the profiles provides sufficient space for the screw to move, thereby reducing the risk of breakage.



Please note that not all profiles are available in black – this colour is available on request.

COMBINATION OPTIONS

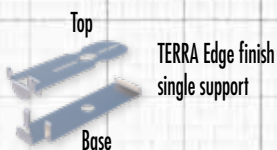

TERRA Aluminium system profile H15*

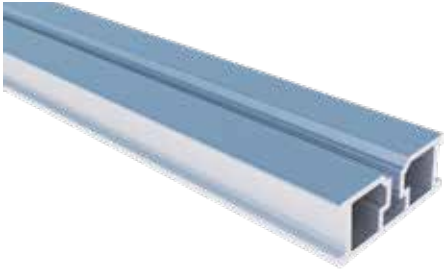

Art. no.	Name	Dimensions [mm] ^{a)}	Colour	Material	PU
975541	TERRA Aluminium System Profile H15	15 x 40 x 4000	-	Aluminium	1
975542	TERRA Aluminium System Profile H15	15 x 40 x 4000	black, RAL 9005	Aluminium	1

^{a)}Height x length x width

TERRA Aluminium system profile H24*



Art. no.	Name	Dimensions [mm] ^{a)}	Colour	Material	PU
975543	TERRA Aluminium System Profile H24	24 x 40 x 4000	-	Aluminium	1
975549	TERRA Aluminium System Profile H24	24 x 40 x 2000	-	Aluminium	1

^{a)}Height x length x width

TERRA Aluminium system profile H50*



Art. no.	Name	Dimensions [mm] ^{a)}	Colour	Material	PU
975545	TERRA Aluminium System Profile H50	50 x 40 x 4000	-	Aluminium	1
975546	TERRA Aluminium System Profile H50	50 x 40 x 4000	black, RAL 9005	Aluminium	1

^{a)}Height x length x width

TERRA Aluminium system profile H85*



Art. no.	Name	Dimensions [mm] ^{a)}	Colour	Material	PU
975547	TERRA Aluminium System Profile H85	85 x 40 x 4000	-	Aluminium	1

^{a)}Height x length x width

Please note that not all profiles are available in black – this colour is available on request.

APPLICATION IMAGEER – CONCEALED FIXING

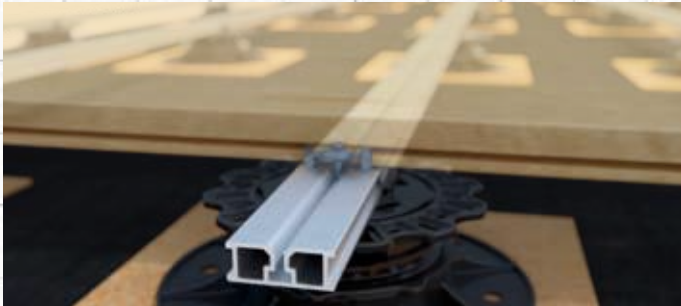

Example of use TERRA Aluminium System Profile H15

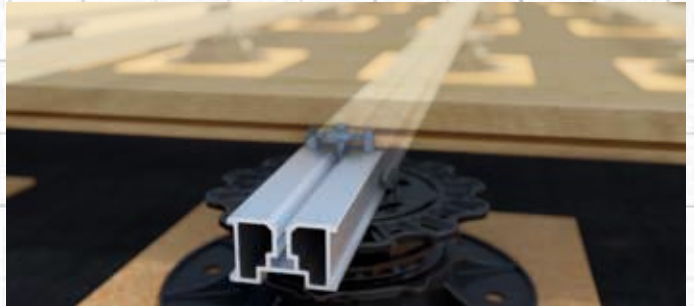

Example of use TERRA Aluminium System Profile H24

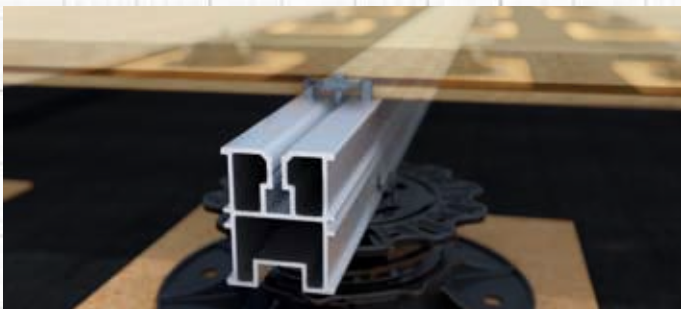

Example of use TERRA Aluminium System Profile H50



Example of use TERRA Aluminium System Profile H85

APPLICATION IMAGEER – VISIBLE FASTENING

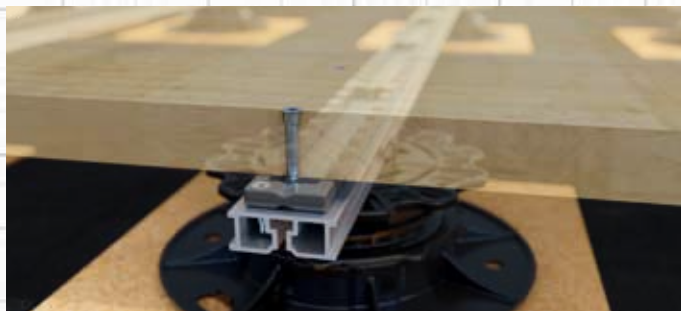

Example of use TERRA Aluminium System Profile H15



Example of use TERRA Aluminium System Profile H24



Example of use TERRA Aluminium System Profile H50

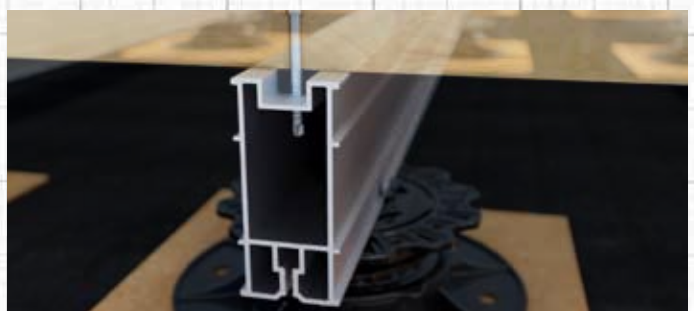

Example of use TERRA Aluminium System Profile H85

THE RIGHT SUPPORT SPACING FOR YOUR TERRACE

The load capacity is determined by the selected substructure, the distances between the adjustable pedestals/supports along the profile and the height and type of the decking.

In the following example, the information is prepared in tabular form depending on the substructure profile used and can be selected from the table corresponding to a payload of 2, 3, 4 or 5 kN/m². A recommended centre distance e is specified with the height and type of the surface covering. For example, a 25 mm larch can be installed with a 500 mm centre distance. When selecting the load capacity/payload of 2.0 kN/m² (200 kg/m²) the support spacing L must be set accordingly every 900 mm along the aluminium substructure profile with a Profi-Line adjustable pedestal with a tested compressive load of 8.0 kN.

Example:

Payload [kN/m ²]	Profi-Line adjustable pedestals, perm. $F = 8,0$ kN							
	Centre distance e [mm] between the profiles ^{b)}							
	300	350	400	450	500	550	600	800
2,0	1000	1000	1000	950	900	850	850	750
3,0 ^{d)}	1000	950	900	850	850	800	800	700
4,0 ^{d)}	900	850	850	800	750	750	700	650
5,0 ^{d)}	850	800	800	750	700	700	650	600

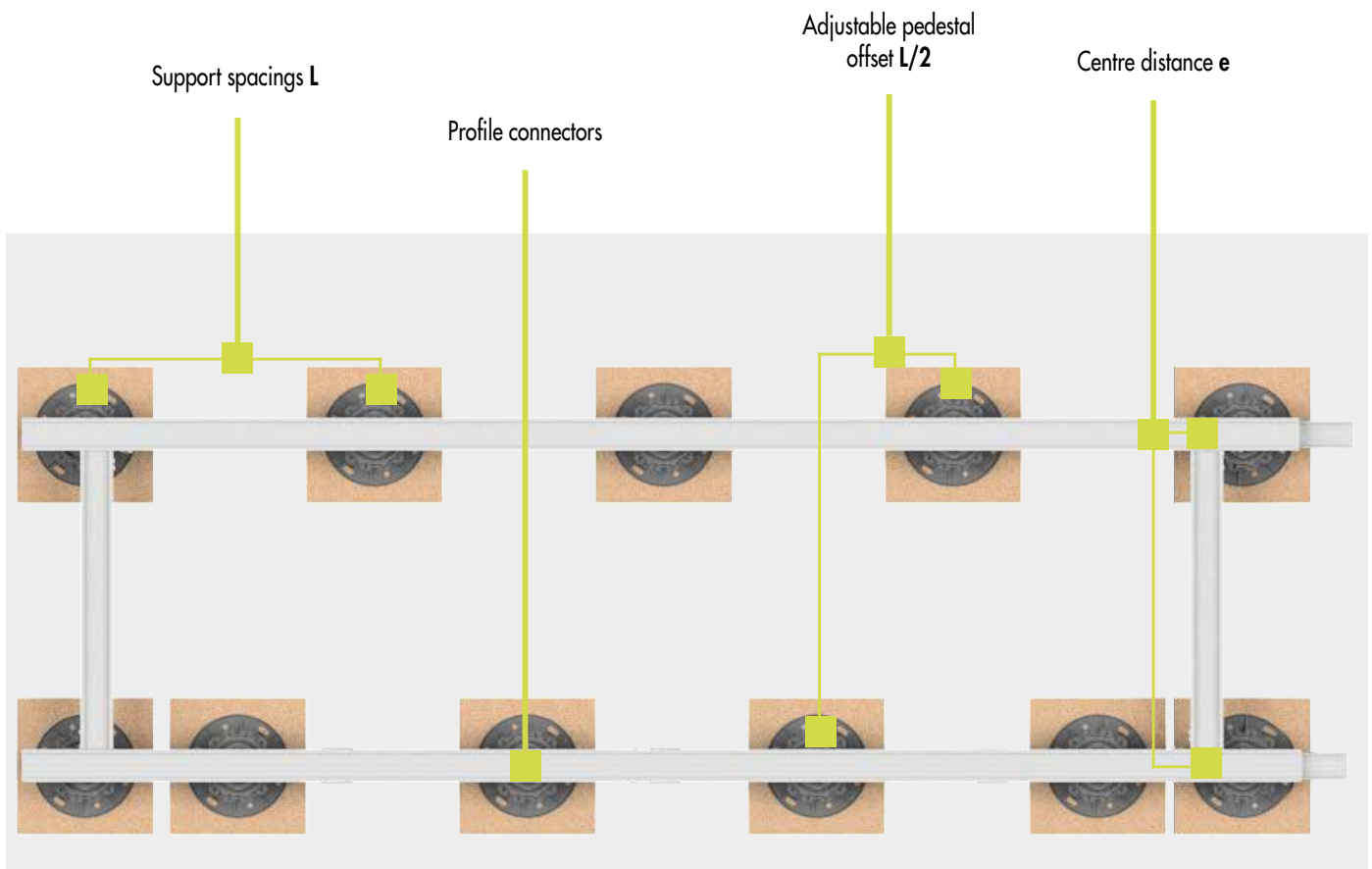

THE RIGHT SUPPORT SPACING FOR YOUR TERRACE

Assessment of support loads^{d)}

- Support force $\leq 2,2$ kN
- Support force 2,3 kN up to 8 kN

Max. support spacing L on adjustable pedestals or concrete for **TERRA Aluminium system profile H15**

Payload [kN/m ²]	Centre distance e [mm] between the profiles ^{b)}								
	e=	250	300	350	400	450	500	550	600
2,0	L=	550	550	500	500	450	450	400	400
4,0 ^{a)}	L=	450	400	400	400	350	350	350	350
5,0 ^{a)}	L=	400	400	350	350	350	300	300	300

Max. support spacing L on adjustable pedestals or concrete for **TERRA Aluminium system profile H24**

Payload [kN/m ²]	Centre distance e [mm] between the profiles ^{b)}								
	e=	250	300	350	400	450	500	550	600
2,0	L=	800	750	700	700	650	650	600	600
4,0 ^{a)}	L=	650	600	550	550	500	500	500	450
5,0 ^{a)}	L=	600	550	550	500	500	450	450	450

Max. support spacing L on adjustable pedestals or concrete for **TERRA Aluminium system profile H50**

Payload [kN/m ²]	Centre distance e [mm] between the profiles ^{b)}								
	e=	250	300	350	400	450	500	550	600
2,0	L=	1200	1400	1350	1300	1250	1200	1200	1150
4,0 ^{a)}	L=	1250	1150	1100	1050	1000	950	950	900
5,0 ^{a)}	L=	1150	1150	1000	1000	950	900	900	850

Max. support spacing L for **TERRA Aluminium system profile H85** Bearing type Single-span beam L^{a)}

Payload [kN/m ²]	Centre distance e [mm] between the profiles ^{b)}								
	e=	250	300	350	400	450	500	550	600
2,0	L=	2500	2350	2250	2150	2050	2000	1900	1850
4,0 ^{a)}	L=	2000	1900	1800	1700	1650	1600	1550	1500
5,0 ^{a)}	L=	1850	1750	1650	1600	1550	1500	1450	1400

Max. support spacing L for **TERRA Aluminium system profile H85** Bearing type Twin-span beam L^{a)}

Payload [kN/m ²]	Centre distance e [mm] between the profiles ^{b)}								
	e=	250	300	350	400	450	500	550	600
2,0	L=	2850	2700	2550	2450	2350	2250	2200	2150
4,0 ^{a)}	L=	2300	2150	2050	1950	1850	1800	1750	1700
5,0 ^{a)}	L=	2100	1950	1900	1800	1750	1700	1600	1600

a) For payloads of 2, 4 and 5 kN/m², with an average decking thickness of 25 mm and a decking density of 7 kN/m³ (larch, pine, Douglas fir). Deflection is limited to L/250.

b) When using WPC decking, the centre-to-centre distance e between the profiles must not exceed 400 mm!

c) Payloads in accordance with DIN EN 1991-1; roof terraces = 4 kN/m², terraces in public spaces = 5 kN/m².

d) Maximum support loads are categorised as follows: support force ≤ 2.2 kN for the Base series of adjustable pedestals, and support force from 2.3 kN to 8 kN for the PRO series of adjustable pedestals.



TERRA MODULAR SYSTEM

TERRA Profile connector H15



Art. no.	Dimensions ^{d)} [mm]	Material	PU*
975564	10 x 2 x 60	Aluminium	10

^{d)}Height x length x width

*Screws are included in the delivery.

The TERRA Profile connector H15 of Eurotec is the ideal fastener for joining two aluminium system profiles in a deck substructure. The TERRA Profile Connector H15 is designed for use with the TERRA Aluminium System Profile H15. For all other profile heights, the Profile connector set for deck edging can be used.



Connecting two profiles using the Profile connector H15

TERRA Multifunctional corner connector



Art. no.	Dimensions ^{d)} [mm]	Materialstärke [mm]	Material	PU*
975596	45 x 45 x 15	2,5	Aluminium	10

^{d)}Height x length x width

*Screws are included in the delivery.

Our TERRA Multifunctional Corner Connector, when used in combination with the TERRA Aluminium system profiles H24, H50 and H85, is highly versatile and is ideal for cross-bracing as well as for vertical profiles. Thanks to its well-engineered design, it allows for the flexible configuration of various joints and ensures stability and safety in a range of structures.

ADVANTAGES

- For joining TERRA profiles at a 90° angle
- Versatile
- Corrosion-resistant

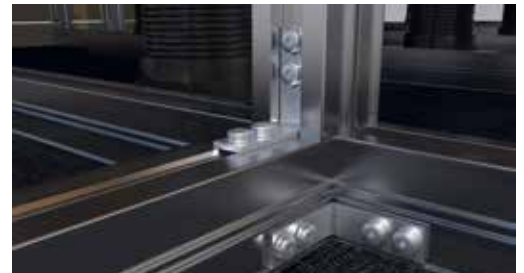

TERRA Corner bracket low



Art. no.	Dimensions ^{d)} [mm]	Material	PU*
975560	10 x 40 x 40	Aluminium	10

^{d)}Height x length x width

*Screws are included in the delivery.

The TERRA Corner connector low of Eurotec is used to create right-angle (90°) connections between two aluminum system profiles, as is often the case with cross bracing, for example. The TERRA Corner connector low should be used for structures built with the TERRA H15 aluminum system profile. For all other profile heights, the Corner connector Eveco can be used.



TERRA Joint 90°



Art. no.	Name	Dimensions ¹⁾ [mm]	Material	PU*
975587	TERRA Gelenk 90°	19 x 50,5 x 78,5	S235 Feuerverzinkt / Niet A2	4
975588	TERRA Gelenk 180°	19 x 11,5 x 131	S235 Feuerverzinkt / Niet A2	4

¹⁾Height x length x width

*Screws are included in the delivery.

The TERRA joints are used to optimally connect the aluminium system profiles. Since the joints can rotate freely on one side, they can be positioned individually along the profile rail. When constructing deck substructures, the TERRA joints are suitable for angles of up to 90° or 180°. The EVO hinge connector is used to align profiles horizontally, allowing, for example, curved deck sections to be created.

TERRA Joint 180°



ADVANTAGES

- Freely rotating joint
- For angles up to 90° or 180°
- Individual positioning on the profile rail
- Rivet made of A2 stainless steel per DIN 6791



Note

For use with TERRA H24/H50/H85 aluminium system profiles only.

TECHNICAL DRAWING

TERRA Joint 90°

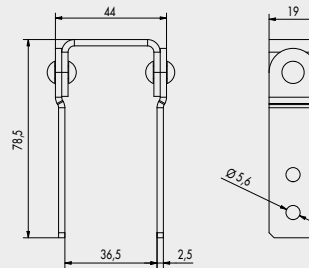

TERRA Joint 180°

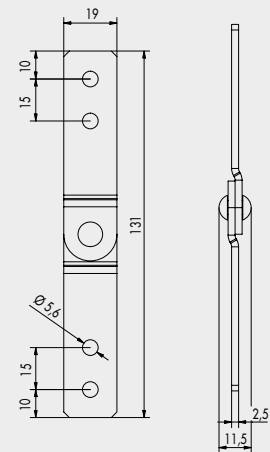

Example of use des TERRA Joint 90°



Example of use des TERRA Joint 180°

TERRA Concrete connector H15

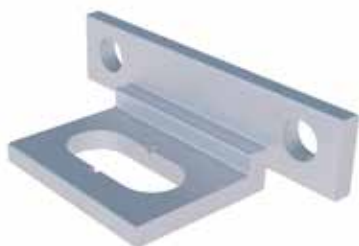

Art. no.	Dimensions ¹⁾ [mm]	Material	PU*
975572	22,75 x 12,75 x 45	Aluminium	10

¹⁾Height x length x width

*Screws are included in the delivery.

The TERRA Concrete connector H15 of Eurotec is designed for directly connecting the TERRA Aluminium system profile H15 to concrete floors. The TERRA Concrete connector H15 is compatible only with the TERRA Aluminium System Profile H15.



Note

For the TERRA H15 aluminium system profile only.



Example of use TERRA Concrete connector H15

TERRA Fascia profile H85

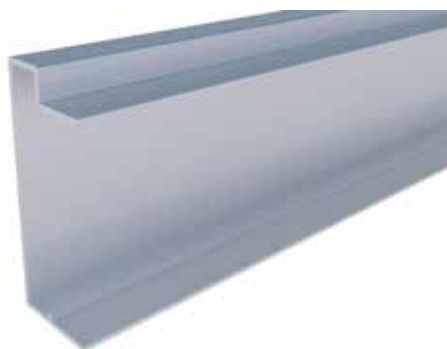

Art. no.	Dimensions ¹⁾ [mm]	Material	PU
975574	87 x 34 x 4000	Aluminium	40

¹⁾Height x length x width

The TERRA Fascia Profile H85 of Eurotec is used in combination with the TERRA Aluminium system profile H85 to form a closed frame around the deck. Using just two system components, an entire deck structure can be created.

ADVANTAGES

- Clean, closed modular system
- Only two system components for an entire terrace substructure
- High dimensional stability and flatness
- Large spans possible
- Low weight
- High flexibility in design and Installation
- High durability



Note

Compatible exclusively with the TERRA H85 aluminium system profile



Example of use TERRA H85 fascia profile



Example of use TERRA H85 fascia profile

TERRA Centre Panel



Art. no.	Name	Dimensions ^{d)} [mm]	Material	PU*
954011	TERRA Centre Panel	19,5 x 82 x 89	PP (Polypropylene)	200
954012	TERRA Edge Cover	31,5 x 82 x 122	PP (Polypropylene)	50

^{d)}Height x length x width

*Screws are included in the delivery.

The TERRA Centre Panel and TERRA Edge Cover were specially developed for the TERRA Aluminium system profiles. These supports make it easy to secure concrete and natural stone slabs to our TERRA Aluminium System Profiles.

ADVANTAGES

- Snaps onto the TERRA system profiles
- To prevent the stone slabs from shifting at the edges, the clips must be secured with a 4.2 x 35 mm aluminium profile drilling screw
- The joint width is 4 mm
- The joint spacers can be separated individually as needed

TERRA Edge Cover



TERRA EDGE COVER

Manufacturing tolerances of up to 2 mm in stone slabs can be compensated for using the movable center piece of the TERRA center cover.



The TERRA Centre Panel used in conjunction with the Ø 90 impact sound disc.



The TERRA Edge Cover used in conjunction with the Ø 90 impact sound disc.





EVO SLIM ALUMINIUM SYSTEM PROFILE

The EVO Slim aluminium system profile is an aluminium substructure for terraces with very low structural heights. Compared with conventional terrace substructures made from wood, this substructure has certain significant advantages:

ADVANTAGES

- A sturdy base surface for direct support
- Universally suitable for direct/visible fastening systems and for indirect/concealed fastening systems.
- The special profile shape reduces the risk of fastening screws being shorn off as the result of swelling and shrinkage movements in the terrace decking boards.
- The special shape prevents the screws from being shorn off.
- Simple, time-saving assembly
- Dimensionally stable, straight, torsion-free
- Resistant to weather, UV exposure, insects and rot
- Supports constructive timber protection
- Low dead load

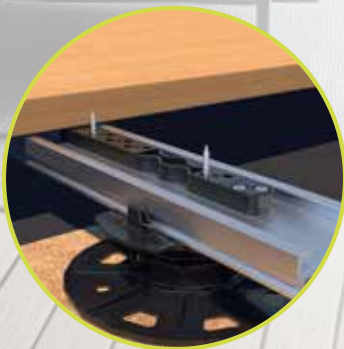

Hidden fastening using deck gliders



Hidden fastening using deck gliders twin system clip



Visible fastening using profile drilling screw

Please note that not all profiles are available in black – this colour is available on request.

COMBINATION OPTIONS



Deck gliders



Twin system clip



Profile drilling screw

EVO Slim aluminium system profile



Art. no.	Dimensions [mm] ^{a)}	Material	PU
975633	20 x 60 x 2400	Aluminium	1
975628	20 x 60 x 4000	Aluminium	1

^{a)}Height x width x profile length

Important

If the Aluminium-System Profile EVO-Slim is installed in combination with the Twin system clip, the note on page 119 needs to be considered.

EVO Slim aluminium system profile connector



Art. no.	Dimensions [mm] ^{a)}	Material	PU*
975629	4 x 200 x 48	Aluminium	10

^{a)}Height x length x width

*Incl. 4 drilling screws per connector.

Note

The profile butt joint is only to be positioned directly above a post or support.



ASSEMBLY INSTRUCTIONS

 MAX. SUPPORT SPACING L [MM] FOR EVO SLIM ALUMINIUM SYSTEM PROFILE WITH ADJUSTABLE PEDESTALS^{a)}

Payload [kN/m ²]	BASE-Line adjustable pedestals, perm. F = 2,2 kN							
	Centre distance e [mm] between the profiles ^{b)}							
	250	300	350	400	450	500	550	600
2,0	650	600	600	550	550	500	500	500
3,0 ^{d)}	550	550	500	500	500	450	450	400
4,0 ^{d)}	500	500	450	450	400	400	400	400
5,0 ^{d)}	500	450	450	400	400	400	350	350

Payload [kN/m ²]	Profi-Line adjustable pedestals, perm. F = 8,0 kN							
	Centre distance e [mm] between the profiles ^{b)}							
	250	300	350	400	450	500	550	600
2,0	650	600	600	550	550	500	500	500
3,0 ^{d)}	550	550	500	500	500	450	450	400
4,0 ^{d)}	500	500	450	450	400	400	400	400
5,0 ^{d)}	500	450	450	400	400	400	350	350

^{a)}Indication of max. span at which the profile's deflection does not exceed L/300. Average board thickness of 25 mm with a specific weight of 7 kN/m³ (larch, pine, Douglas fir).

^{b)}E. g.: spacing between profiles = 550 mm; payload = 2,0 kN/m² → max. span of the profile = 500 mm.

^{c)}Payloads according to DIN EN 1991-1; roof terraces = 4 kN/m², deck for public use = 5 kN/m².

^{d)}Load capacity according to SIA 261 for balconies and roof terraces private use = 3 kN/m².

NOTE

Please refer to the assembly instructions in our product data sheet.



EVO LIGHT ALUMINIUM SYSTEM PROFILE

THE
COST-EFFECTIVE
ALTERNATIVE



The aluminium system profile EVO Light was developed especially for grooved WPC/BPC coverings. Thanks to the walls and the perfectly utilised geometry of the EVO Light aluminium system profile, it has very high sturdiness.

ADVANTAGES

- Hidden fastening with the EVO Light system bracket
- Visible fastening possible with profile and wing-tipped profile drilling screws
- Can also be used with PRO adjustable pedestals and L adapter
- Can be lengthened with EVO Light system connector
- Position retention due to screw of L adapter
- Load-bearing, torsion-free, form-stable and straight
- Special shape prevents screws from shearing off



Hidden fastening using EVO Light system clip



Visible fastening using profile drilling screw

Please note that not all profiles are available in black – this colour is available on request.

COMBINATION OPTIONS



EVO Light system clip



Profile drilling screw

EVO Light aluminium system profile



Art. no.	Dimensions [mm] ⁰⁾	Material	PU
975643	32 x 34 x 4000	Aluminium	1

⁰⁾Height x width x profile length



Use the aluminium concrete bracket (Art.-no.: 975661) for fixing to concrete.

EVO Light system connector



Art. no.	Dimensions [mm] ⁰⁾	Material	PU
975618	27,7 x 27,4 x 62,5	Plastic	10

⁰⁾Height x width x length

For connecting the aluminium EVO Light system profiles together. The EVO Light system connector has the advantage that it connects the profiles without screws, simply by plugging them together.



Example of application EVO Light system connector

Corner connectors

Suitable for EVO Light aluminium system profiles

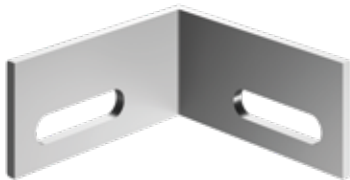

Art. no.	Dimensions [mm] ⁰⁾	Material	PU*
975631	19 x 40 x 40	Aluminium	10

⁰⁾Height x width x length
*Incl. 20 screws



Example of application corner connector



MAX. SUPPORT SPACING (L) FOR EVO LIGHT ALUMINIUM SYSTEM PROFILE WITHOUT ADJUSTABLE PEDESTALS, E. G. ON CONCRETE FOUNDATIONS^{a)}

Payload [kN/m ²]	Centre distance e [mm] between profiles ^{b)}							
	250	300	350	400	450	500	550	600
2,0	950	900	850	850	800	750	750	700
4,0 ^{d)}	800	750	700	650	600	600	600	550
5,0 ^{d)}	700	700	650	600	550	550	550	500

^{a)}Max. support spacing (L) for load capacities of 2, 4 and 5 kN/m², with an average board thickness of 25 mm and a specific board weight of 7 kN/m³ (larch, pine, Douglas fir).

^{b)}If WPC boards are used, the centre distance e between the profiles must not exceed 400 mm!

^{d)}Load capacities according to DIN EN 1991-1; roof terraces = 4 kN/m², decks for public use = 5 kN/m².

MAX. SUPPORT SPACING (L) FOR EVO LIGHT ALUMINIUM SYSTEM PROFILE WITH ADJUSTABLE PEDESTALS^{a)}

Payload [kN/m ²]	BASE adjustable pedestals, perm. F = 2,2 kN							
	Centre distance e [mm] between profiles ^{b)}							
	250	300	350	400	450	500	550	600
2,0	950	900	850	850	800	750	750	700
3,0 ^{d)}	850	800	750	750	700	650	650	600
4,0 ^{d)}	800	750	700	650	600	550	500	450
5,0 ^{d)}	700	700	650	550	500	450	400	350

Payload [kN/m ²]	PRO adjustable pedestals, perm. F = 8,0 kN							
	Centre distance e [mm] between profiles ^{b)}							
	250	300	350	400	450	500	550	600
2,0	950	900	850	850	800	750	750	700
3,0 ^{d)}	850	800	750	750	700	650	650	600
4,0 ^{d)}	800	750	700	650	600	600	600	550
5,0 ^{d)}	700	700	650	600	550	550	550	500

^{a)}Max. support spacing (L) for load capacities of 2, 3, 4 and 5 kN/m², with an average board thickness of 25 mm and a specific board weight of 7 kN/m³ (larch, pine, Douglas fir).

^{b)}If WPC boards are used, the centre distance e between the profiles must not exceed 400 mm!

^{d)}Load capacities according to DIN EN 1991-1; roof terraces = 4 kN/m², decks for public use = 5 kN/m².

^{e)}Load capacity according to SIA 261 for balconies and roof terraces private use = 3 kN/m².





EVECO ALUMINIUM SYSTEM PROFILE

FOR GROOVED DECKING BOARDS

The Aluminum Profile System Eveco is an aluminum substructure for terraces which were developed specifically for the use of fastening clips. This profile is suitable for terrace coverings with grooved sides.

ADVANTAGES

- Can be combined with M-clip for hidden fastening
- Universal: can also be used with many other fastening clips (screw diameter: 4,2 mm)
- Developed specially for PRO adjustable feet with Click adapter
- In case of low structure height, the profile can be used without pedestals
- Position retention thanks to Click system without screws
- Load-bearing, torsion-free, form-stable and straight
- Screw channels avoid lengthy drilling times



Hidden fastening using M-Clip

COMBINATION OPTIONS



M-Clip

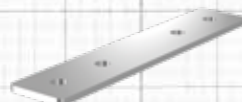

Profile connector deck edging set

Eveco aluminium system profile

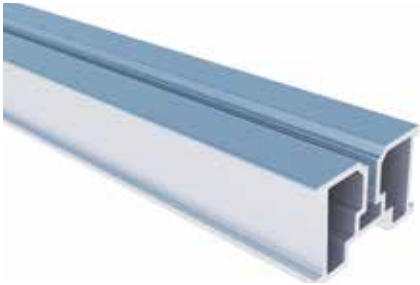

Art. no.	Dimensions [mm] ⁰⁾	Material	PU
975632	24 x 39 x 2400	Aluminium	1
975630	24 x 39 x 4000	Aluminium	1
S975630	24 x 39 x 4000	Aluminium, black	1

⁰⁾ Height x width x Profile length



Use the aluminium concrete bracket (Art.-no.: 975661) for fixing to concrete.

Profile connector deck edging set

For extending the end profiles

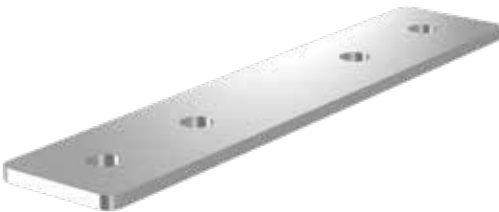

Art. no.	Dimensions [mm]	Material thickness [mm]	Material	PU
975642	100 x 20	2	Aluminium	2

SET CONSISTS OF

- 2 profile connectors
- 8 drilling screws 4,8 x 25 mm



Example of application profile connector deck edging set

Eveco corner connector

For Eveco aluminium system profiles

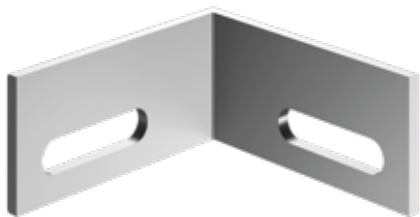

Art. no.	Dimensions [mm] ⁰⁾	Material	PU*
975631	19 x 40 x 40	Aluminium	10

⁰⁾ Height x width x length

* Incl. 20 screws

MAX. SUPPORT SPACING (L) FOR EVECO ALUMINIUM SYSTEM PROFILE WITHOUT ADJUSTABLE PEDESTALS, E. G. ON CONCRETE FOUNDATIONS^{a)}

Payload [kN/m ²]	Centre distance e [mm] between profiles ^{b)}							
	300	350	400	450	500	550	600	800
2,0	800	750	750	700	700	650	650	600
4,0 ^{d)}	650	600	600	550	550	500	500	450
5,0 ^{d)}	600	550	550	500	500	500	450	450

^{a)}Indication of max. span at which the profile's deflection does not exceed L/300. Average board thickness of 25 mm with a specific weight of 7 kN/m³ (larch, pine, Douglas fir).

^{b)}E. g.: spacing between profiles = 550 mm; payload = 2,0 kN/m² → max. span of the profile = 650 mm.

^{d)}Payloads according to DIN EN 1991-1; roof terraces = 4 kN/m², deck for public use = 5 kN/m².

MAX. SUPPORT SPACING L [MM] FOR EVECO ALUMINIUM SYSTEM PROFILE WITH ADJUSTABLE PEDESTALS^{a)}

Payload [kN/m ²]	BASE adjustable pedestals, perm. F = 2,2 kN							
	Centre distance e [mm] between profiles ^{b)}							
	250	300	350	400	450	500	550	600
2,0	800	750	700	650	650	600	600	600
3,0 ^{d)}	700	650	600	600	550	550	500	450
4,0 ^{d)}	650	600	550	550	500	450	400	350
5,0 ^{d)}	600	550	500	450	400	350	300	300

Payload [kN/m ²]	PRO adjustable pedestals, perm. F = 8,0 kN							
	Centre distance e [mm] between profiles ^{b)}							
	250	300	350	400	450	500	550	600
2,0	800	750	700	650	650	600	600	600
3,0 ^{d)}	700	650	600	600	550	550	550	500
4,0 ^{d)}	650	600	550	550	500	500	500	450
5,0 ^{d)}	600	550	500	500	500	450	450	450

^{a)}Indication of max. span at which the profile's deflection does not exceed L/300. Average board thickness of 25 mm with a specific weight of 7 kN/m³ (larch, pine, Douglas fir).

^{b)}E. g.: spacing between profiles = 550 mm; payload = 2,0 kN/m² → max. span of the profile = 600 mm.

^{d)}Load capacities according to DIN EN 1991-1; roof terraces = 4 kN/m², decks for public use = 5 kN/m².

^{e)}Load capacity according to SIA 261 for balconies and roof terraces private use = 3 kN/m².

Cross bracing Eveco



INSTRUCTIONS FOR USE

The cross bracings can only be used with a centre distance of 40 mm.

Art. no.	Name	Material	Dimensions [mm] ^{a)}	PU
975667	Cross bracing Eveco	Aluminium	24 x 40 x 361	1

^{a)} Height x width x Profile length

Our cross bracing is the perfect complement to our aluminium profiles. The pre-mounted brackets make installation even easier.

ADVANTAGES

- Simple, time-saving assembly
- Faster completion of the terraces
- The prefabricated cross bracing prevents the costly process of cutting the profiles on the construction site.
- Clean prefabrication ensures professional assembly



Example of application cross bracing Eveco

ACCESSORIES ALUMINIUM SYSTEM PROFILES

Aluminium concrete bracket

For fixing to concrete



Art. no.	Dimensions [mm] ^{a)}	Ø Round hole [mm]	Slotted hole [mm] ^{b)}	PU*
975661	19,75 x 22,75 x 30	8	20 x 4,5	10

^{a)} Height x length x width

^{b)} Length x width

*Delivery includes one 4,2 x 17 mm Thermofix screw.

The rock concrete screw for fixing to concrete is not included in the scope of delivery and must be ordered separately.

INSTRUCTIONS FOR USE

The aluminium concrete bracket is fixed to the aluminium through the slotted hole using the 4,2 x 17 mm Thermofix screw supplied. The slotted hole can be used to compensate for material expansion of the aluminium.

The round hole is used for fixing to concrete with the 7,5 mm rock concrete screw hexagonal/hexagonal with flange.

Can be combined with our aluminium system profiles EVO, EVO Light and Eveco.



Aluminium concrete bracket in conjunction with the EVO aluminium system profile

MaTre band

For material separation

**Suitable for
EVO, EVO
Light and
HKP**



Art. no.	Dimensions [mm] ^{a)}	PU
945319	0,5 x 10 x 20000	5

^{a)} Height x width x length

The MaTre band is used for material separation and thus prevents creaking noises between the aluminium profiles and planks.

ADVANTAGES

- Easy attachment thanks to an adhesive film
- Optimal fit through a very thin material
- Tear resistant and durable
- Screws can be easily screwed
- Can be cut to length individually



Example of application MaTre band



ALUMINIUM DECK SUPPORT SYSTEM HKP

The deck support system comprises an aluminium substructure that allows spans of up to 3 m, depending on the desired loading capacity. The support system can therefore be tailored flexibly to meet a wide range of requirements. It is used especially on decks installed near to the ground in which only a few auxiliary supports are laid. Its versatile range of applications also includes elevated decks, load-bearing balconies and overhanging decks near to the ground. The deck support system consists of two components that are joined together to form a closed, load-bearing system.

ONE SYSTEM, MANY ADVANTAGES

- High load bearing capability
- Large support widths
- High dimensional stability and evenness
- Low dead load
- High flexibility
- High durability
- Attractive, clean enclosed frame
- Material savings

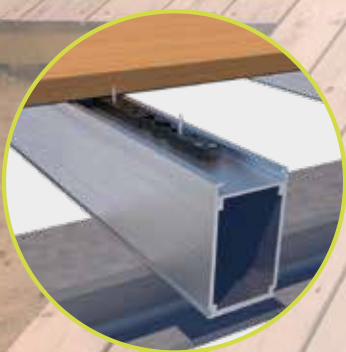

Hidden fastening using deck gliders

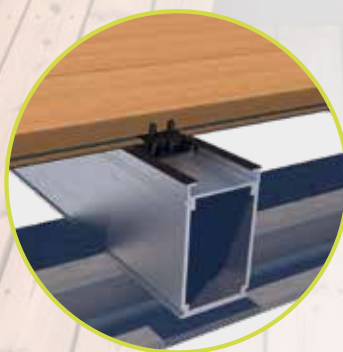

Hidden fastening using deck gliders twin system clip



Visible fastening using profile drilling screw

Please note that not all profiles are available in black – this colour is available on request.

COMBINATION OPTIONS



Deck gliders



Twin system clip



Profile drilling screw

Aluminium support-profile connector

For support-profile HKP



Art. no.	Dimensions [mm] ¹⁾	Material	PU*
954670	74 x 50 x 250	Aluminium	1

¹⁾ Height x width x length

*Incl. 8 drilling screw per connector



Note

The profile butt joint is only to be positioned directly above a post or support.



Example of application aluminium support-profile connector

BiGHTY PH

Stainless steel, hardened

Suitable for this



Art. no.	Dimensions [mm]	Drive	PU
954090-50	4,8 x 25	TX20 ●	50





ASSEMBLY INSTRUCTIONS

MAXIMUM SUPPORT DISTANCES L [MM] A) FOR SUPPORTS MADE OF CONCRETE OR STEEL

Bearing type	Payload kN/m ²	Axis clearance e [mm] of support profile HKP to one another ^{b)}						
		300	350	400	450	500	550	600
Single-span beam L 	2,0	3000	2750	2750	2500	2500	2500	2250
	3,0 ^{d)}	2750	2500	2500	2250	2250	2250	2000
	4,0 ^{d)}	2500	2250	2250	2000	2000	2000	2000
	5,0 ^{d)}	2250	2000	2000	2000	1750	1750	1750
Twin-span beam L [mm] 	2,0	3000	3000	3000	3000	3000	2750	2750
	3,0 ^{d)}	3000	2750	2500	2500	2500	2500	2250
	4,0 ^{d)}	2750	2500	2500	2500	2250	2250	2250
	5,0 ^{d)}	2500	2500	2250	2250	2000	2000	2000
Single-span cantilever beam L [mm] / Lk [mm] 	2,0	3000 / 1000	2750 / 1000	2750 / 1000	2500 / 1000	2500 / 1000	2000 / 1000	1750 / 1000
	3,0 ^{d)}	2500 / 1000	2500 / 1000	2500 / 750	2500 / 750	2500 / 750	2000 / 750	1750 / 750
	4,0 ^{d)}	1750 / 1000	1500 / 750	1500 / 750	1500 / 750	1500 / 750	1500 / 750	1500 / 750
	5,0 ^{d)}	1500 / 750	1500 / 750	1500 / 750	1500 / 750	1500 / 750	1250 / 750	1250 / 750

^{a)}Max. bearing clearances (L) for bearings with „direct support“ with payloads of 2, 3, 4 and 5 kN/m², with a mean board thickness of 25 mm and a board weight of 7 kN/m².

^{b)}If WPC boards are used, the axis clearance e between the profiles must not exceed 400 mm!

^{c)}Payloads in accordance with DIN 1055-3:2006, roof terraces = 4 kN/m², terraces in public = 5 kN/m².

^{d)}Load capacity according to SIA 261 for private balconies and roof terraces = 3 kN/m².

MAXIMUM SUPPORT DISTANCES (L) FOR ADJUSTABLE FEET OF THE PRO-LINE (PERMITTED F = 8,0 KN

Bearing type	Payload kN/m ²	Maximum support distances L [mm] with the adjustable pedestals of the PRO-Line series with a HKP support profile ^{a)}						
		300	350	400	450	500	550	600
Single-span beam L 	2,0	3000	2750	2750	2500	2500	2500	2500
	3,0 ^{d)}	2750	2500	2500	2250	2250	2250	2000
	4,0 ^{d)}	2500	2250	2250	2000	2000	2000	2000
	5,0 ^{d)}	2250	2000	2000	2000	1750	1750	1750
Twin-span beam L [mm] 	2,0	3000	3000	3000	3000	3000	2750	2500
	3,0 ^{d)}	3000	2750	2500	2250	2000	1750	1750
	4,0 ^{d)}	2500	2250	2000	1750	1500	1250	1250
	5,0 ^{d)}	2000	1750	1500	1250	1250	1000	1000
Single-span cantilever beam L [mm] / Lk [mm] ^{d)} 	2,0	3000 / 1000	2750 / 1000	2750 / 1000	2500 / 1000	2500 / 1000	2000 / 1000	1750 / 1000
	3,0 ^{d)}	2500 / 1000	2500 / 1000	2500 / 750	2500 / 750	2500 / 750	2000 / 750	1750 / 750
	4,0 ^{d)}	1750 / 1000	1500 / 750	1500 / 750	1500 / 750	1500 / 750	1500 / 750	1500 / 750
	5,0 ^{d)}	1500 / 750	1500 / 750	1500 / 750	1500 / 750	1250 / 750	1250 / 500	1250 / 500

^{a)}Max. bearing clearances (L) for bearings with adjustable pedestals of the PRO-Line series with payloads of 2, 3, 4 and 5 kN/m², with a mean board thickness of 25 mm and a board weight of 7 kN/m² (larch, pine, Douglas fir).

^{b)}If WPC boards are used, the axis clearance e between the profiles must not exceed 400 mm!

^{c)}Load capacities according to DIN EN 1991-1; roof terraces = 4 kN/m², decks for public use = 5 kN/m².

^{d)}Lifting forces of up to 1 kN can be sustained on support A.

^{e)}Load capacity according to SIA 261 for balconies and roof terraces private use = 3 kN/m².

Note

This table provides an overview only of the load bearing capability. The information on load bearing capability in the technical information must be noted!

ALUMINIUM FUNCTION STRIPS / DILO

Optimal for terraces with low installation heights

Aluminium function strip



Art. no.	Dimensions [mm] ^{a)}	Material	PU
945510	29 x 34 x 1750	Aluminium	1

^{a)} Height x width x Profile length

For the direct attachment of decking boards of 21 – 25 mm thickness

See Profile drilling screw and Wing-tipped profile drilling screw.



With glued-in cork insert



Aluminium function strip DiLo



Art. no.	Dimensions [mm] ^{a)}	Material	PU*
945535	29 x 34 x 2240	Aluminium	1

^{a)} Height x width x Profile length

* Cork pads are not included with this product

See DiLo drilling screws for hidden fastening of deck boards with a thickness of 20 – 30 mm

PROPERTIES

- Holes: 5,1 mm
- Distance from hole to hole: 20 mm
- Distance from edge to first hole: 10 mm

Cork pad with adhesive tape

For DiLo aluminium function strip

Suitable for this



Art. no.	Dimensions [mm] ^{a)}	PU
945331	17 x 28 x 90	100

^{a)} Height x width x length



Pull off the protective film



DiLo drilling screw

Hardened stainless steel

Suitable for this



Art. no.	Dimensions [mm]	Drive	Board thickness	PU*
111860	5,0 x 28,5	TX25 •	mind. 20 mm	200
111861	5,0 x 33,5	TX25 •	mind. 25 mm	200
111862	5,0 x 38,5	TX25 •	mind. 30 mm	200

*Service classes. 1 Bit

ADVANTAGES

- Limited resistance to acid
- 10 years experience without corrosion problems with suitable woods
- Not suitable for woods containing high amounts of tanning agents, such as cumarú, oak, merbau, robinia, etc.
- Not suitable for use in chlorous atmospheres
- Stainless steel in accordance with DIN 10088

ACCESSORIES FOR BUILDING A TERRACE WITH CANTILEVER

The T-beam anchor is a fastener that was specifically designed for **connecting wood beams**, or the **Eurotec HKP support profile**, to steel beams. It is also perfect for use in the previous example: terrace with cantilever. The **T-beam anchors** should always be attached in pairs and diagonally across each other to be able to uniformly absorb the forces occurring. The three large holes also enable **installation on concrete parts**.

T-beam anchor



Art. no.	Dimensions [mm] ^{a)}	Material thickness [mm]	Material	PU
904119	50 x 160	3	Steel S 250 GD + Z 275	100
904120	50 x 180	3	Steel S 250 GD + Z 275	100
904121	50 x 200	3	Steel S 250 GD + Z 275	100

^{a)}Width x height

ADVANTAGES

- Quick and easy assembly
- Specifically designed for fastening to T-beams



Note

For mounting on wood, we recommend our angle fitting screw. Our BiGHTY PH is recommended for mounting on aluminium.

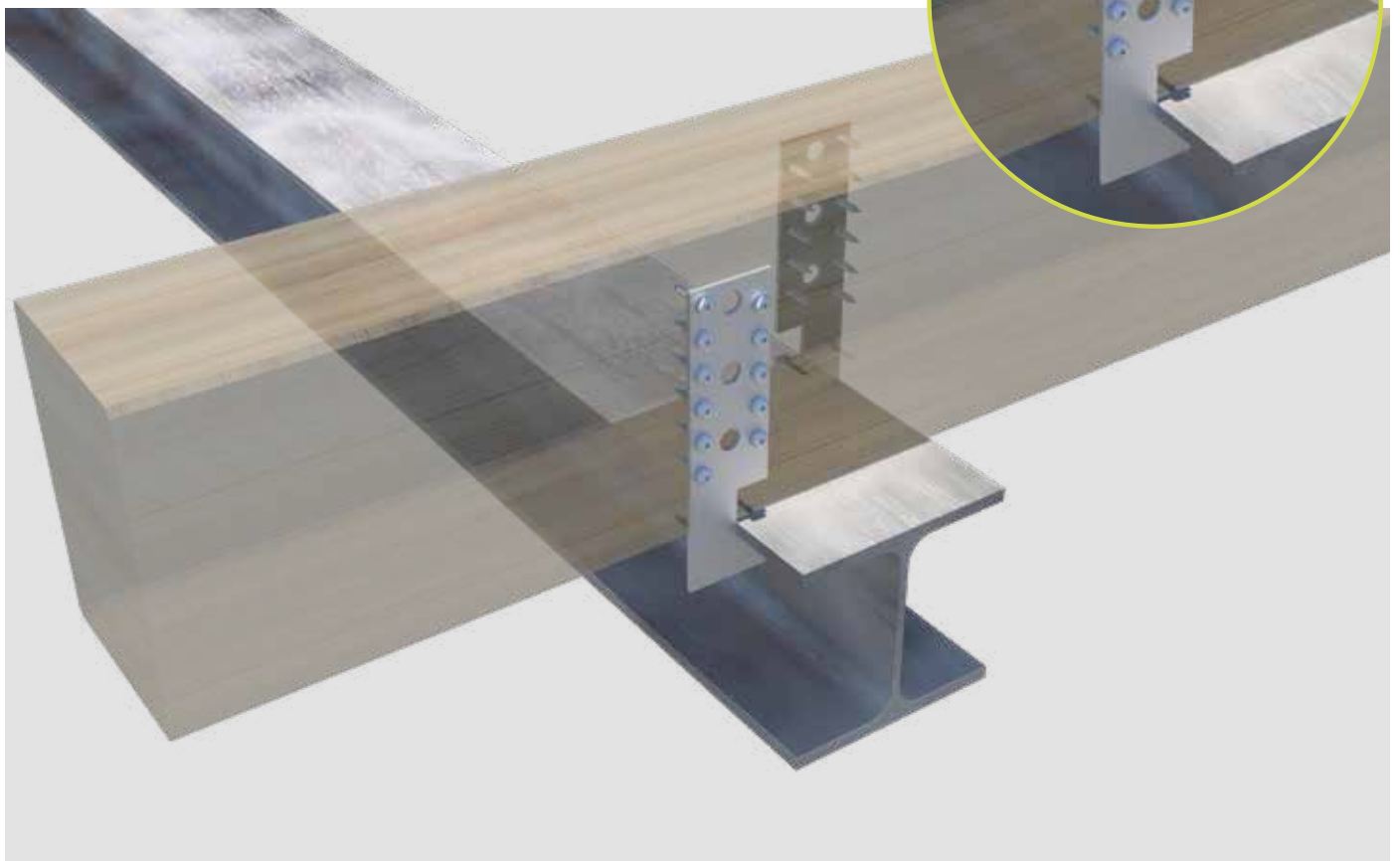

T-beam anchor in conjunction with a T-beam.

TERRACE EDGING

5





EDGE FINISH SINGLE SUPPORT

Perfect for stone terraces

The Eurotec edge finish single support is a simple, top quality way of forming edge finishes for stone terraces with individual support. The set is made up of two stainless steel profiles, one of which is placed on top of the adjustable foot and one underneath it, so that the cut slabs are bordered at the top and bottom. For this to work, the stones must be cut to the desired height and then inserted between the frames. The edge finish single support can be combined with the Eurotec adjustable feet professional line S – XL, along with GIANT S – XL.

Edge finish single support

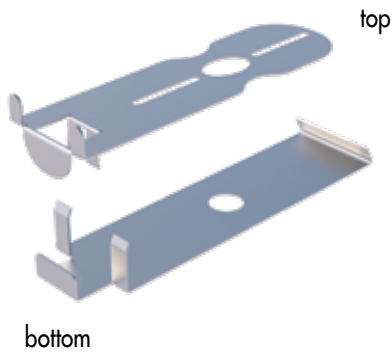

Art. no.	Name	Dimensions [mm] ^{a)}	Material	PU
975606 -OBEN	top	32,5 x 55 x 188	1.4016 according to EN 10088	10
975606 -UNTEN	bottom	29,5 x 55 x 216	1.4016 according to EN 10088	10

^{a)} Height x width x length

ADVANTAGES

- Simple assembly - no screws or drilling required
- Top quality stainless steel edge support - no danger of corrosion
- Frames help prevent subsequent slipping of the stone slabs.



Both individual parts are placed under and on top of the adjustable pedestal GIANT.



Both individual parts are placed under and on top of the adjustable pedestal PRO.





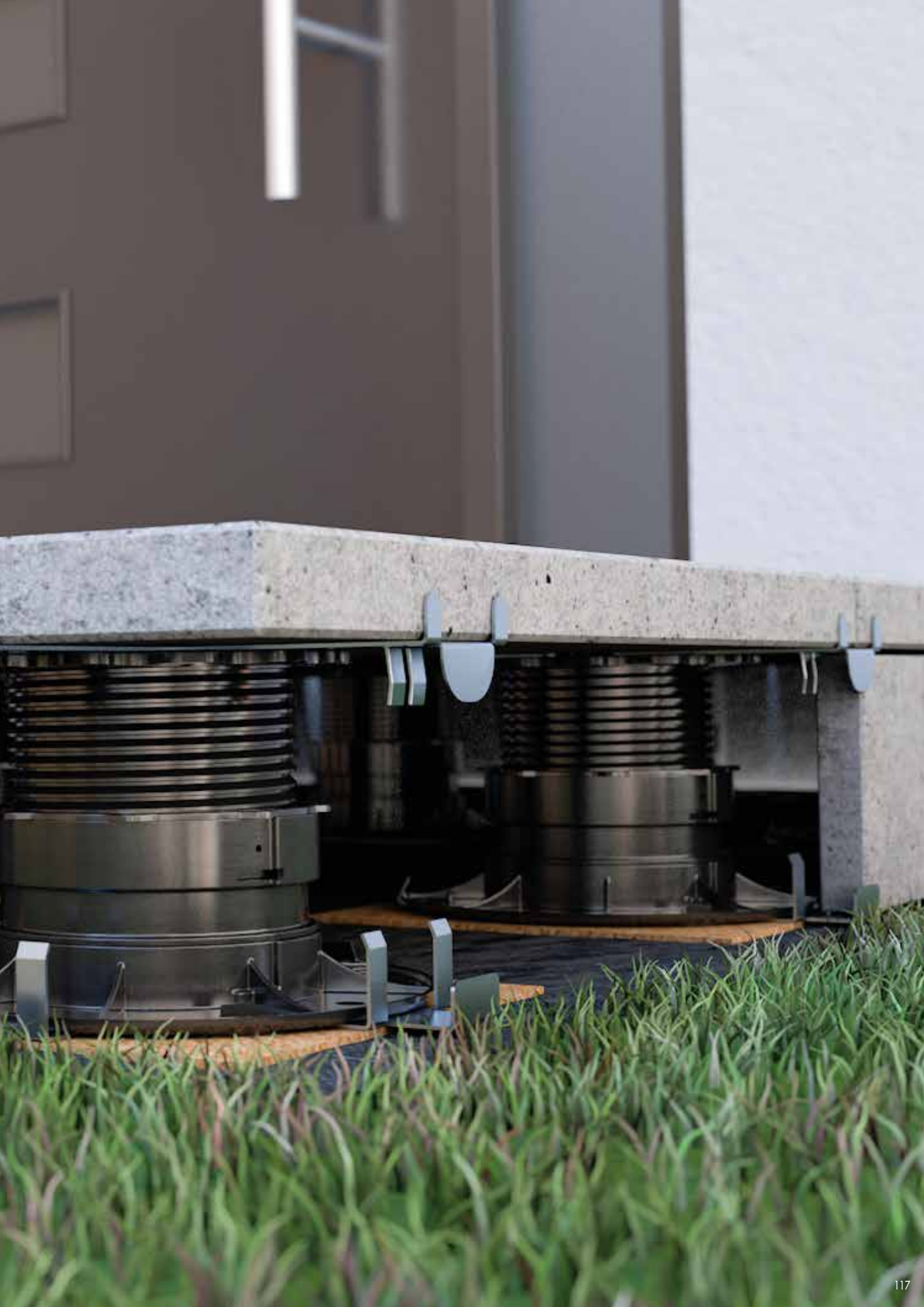

COVER PROFILE

For edge and end cover of the decking

The area of application of the new cover profile is the head end or the butt joint of the decking. Due to the specific surface, the screen profile is able to guarantee no risk of slipping even in wet conditions. Thanks to the flat geometry, the cover profile does not represent a tripping hazard. Our cover profile can be freely combined with all commercially available decking boards.

Cover profile



Art. no.	Dimensions [mm] ^{a)}	Material thickness [mm]	PU
975651	27,5 x 37,5 x 2400	2,5	1

^{a)} Height x width x Profile length

ADVANTAGES

- Quick and easy assembly
- Freely combinable with all available decking boards
- Ensures a non-slip surface even in wet conditions
- Flat geometry prevents tripping hazards
- Resistant to weather, UV exposure, insects and rot

APPLICATION INFORMATION

Fixing is done with countersunk screws ($\varnothing \leq 4$ mm) through the prefabricated holes, which are arranged at an axis-centre distance of 20 cm. Due to the small edge distance of the screw, it is recommended that you pre-drill!



Example of application cover profile – 90°

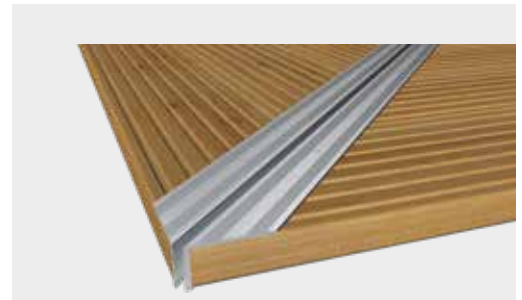

Example of application cover profile – 45°



DECK END PROFILE FOR ALUMINIUM SUBSTRUCTURES

For terraces with flagstone flooring

The Eurotec deck end profiles for aluminium substructures deliver a **visually attractive border** on decks with stone slab flooring in combination with the Profi-Line adjustable pedestals and the EVO aluminium system profile. The system **consists of two end profiles**, which enclose the deck's upper and lower edges respectively.

End profiles for aluminium substructure

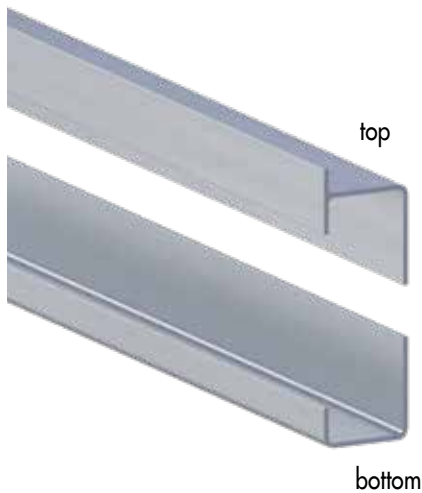

Art. no.	Name	Dimensions [mm] ^{a)}	Material thickness [mm]	Material	PU
975639	top	61,5 x 45 x 2000	2,5	Aluminium	1
975640	bottom	50 x 45 x 2000	2,5	Aluminium	1

^{a)} Height x width x Profile length

Note: for slab thicknesses ≤40 mm

ADVANTAGES

- Visually attractive border
- Versatile applications

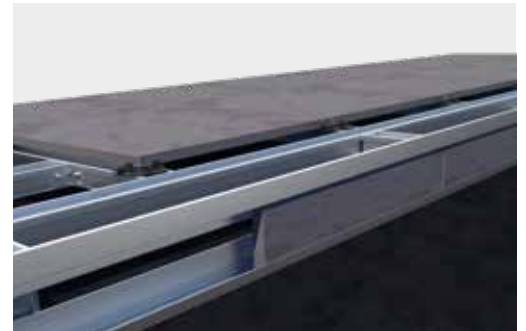

Example of application end profiles for aluminium substructure



Notes

The product only includes the particular aluminium end profiles. All other components must be ordered separately. Per fastening, these include: EVO aluminium system profiles, 90° EVO joint, EVO corner connector and 6x BiGHTY 4,8 x 25 mm drilling screws (art. no. 954090-50, PU: 50). (4x for the 90° EVO joint and 1x each for the connections to the top and bottom deck edging end profiles). For slab thicknesses of less than 40 mm, the resulting free space must be filled with compression seal tape.

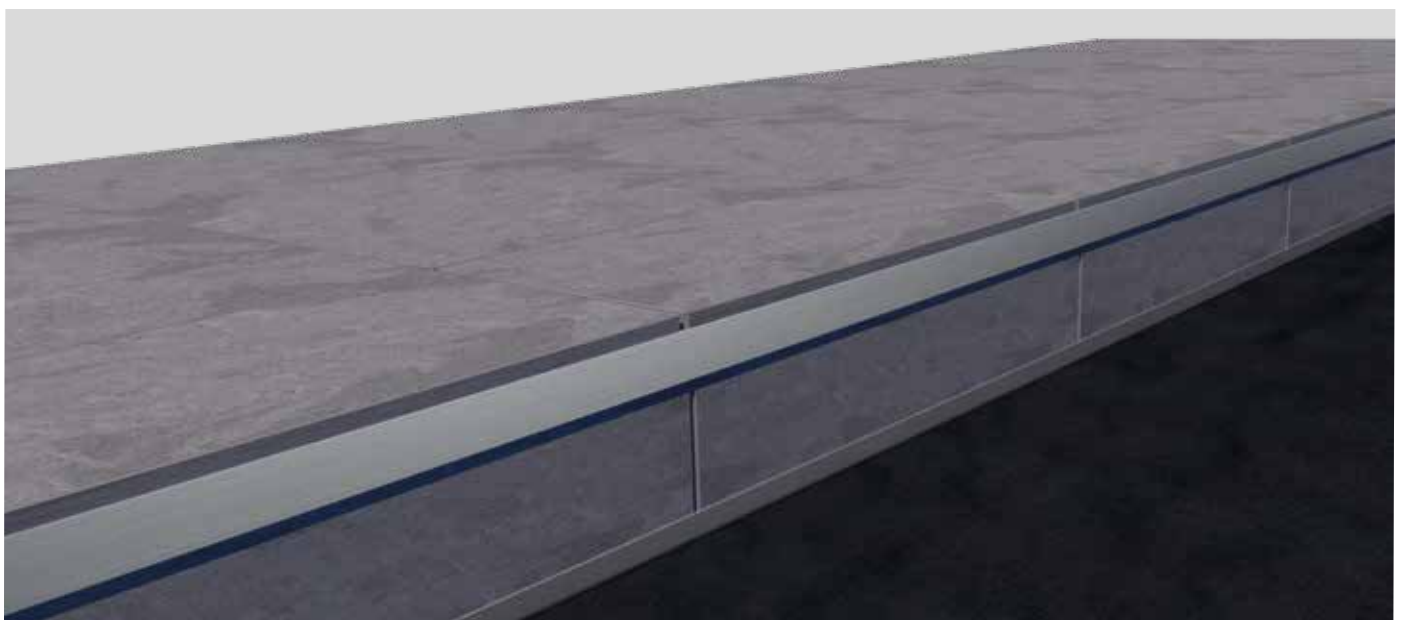

ALUMINIUM COVER

For visually appealing edging

The aluminium cover can be combined with the tops of the terrace edge profiles for an aluminium substructure and single bearing or with the stone-edge clip to a high-quality terrace edge.

Aluminium cover



Art. no.	Dimensions [mm] ¹⁾	Material thickness [mm]	Material	PU
975655	116 x 7 x 2000	2	Aluminium	1

¹⁾ Height x width x length

ADVANTAGES

- Easy assembly
- Flexible border design
- It is possible to match the complete edge structures together
- Can be combined with all standard gutter systems/eaves fascia



Example of application aluminium cover



ALUMINIUM EAVES

For visually appealing edging

The aluminium eaves offers an additional opportunity to form the terrace edge. It is available in 3 cm and 5 cm in height. The aluminium eaves forms the lower part or the entire panel for smaller heights. Combined with the aluminium cover, the side openings can be closed.

Aluminium eaves



Art. no.	Name	Dimensions [mm] ¹⁾	Material thickness [mm]	Material	PU
975653	Aluminium eaves 3 cm	72 x 104 x 2000	1,8	Aluminium	1
975654	Aluminium eaves 5 cm	92,8 x 104 x 2000	1,8	Aluminium	1

¹⁾ Height x width x Profile length

ADVANTAGES

- Easy assembly
- Elegant view
- Flexible border design
- It is possible to coordinate the complete edge structure
- Freely combinable with all standard gutter systems
- The lower sheets are enclosed within the sealing
- Integrated water drainage



Example of application aluminium eaves

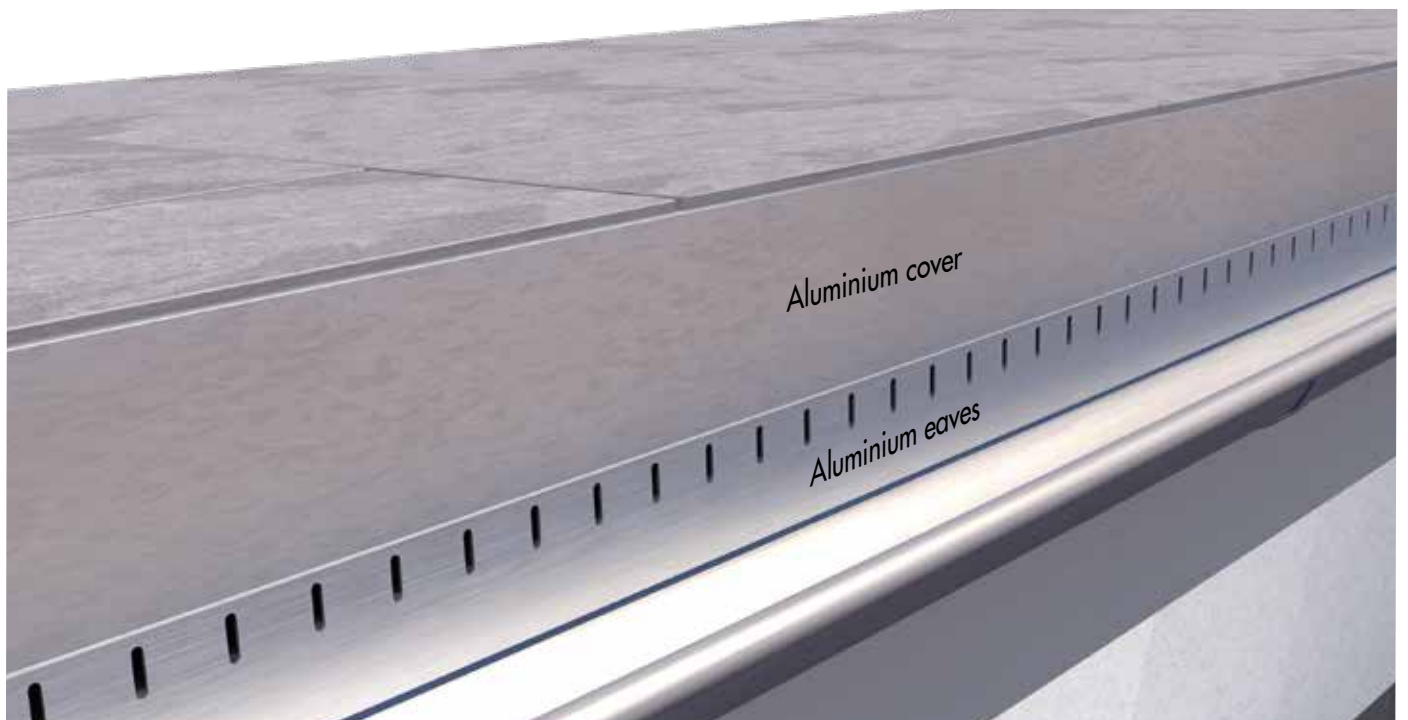

DRAINTEC – ALUMINIUM DRAINAGE GRATE

The DrainTec aluminium drainage grate is used for controlled water drainage. The DrainTec drainage grate focuses mainly on the connection detail of building openings. This refers to door connection areas, or transitions from vertical façade surfaces to horizontal terrace surfaces, for example. The wood preservation standard DIN 68800-2:2012 and the flat roof directive were taken into account in its development.

Thanks to its special geometry, it is able to “catch” precipitation. This causes the water to be channelled directly to the seal or the gutter, without exposing the door element or the façade cladding to reflected water (backspray). Heavy rain is drained in a controlled manner. Thanks to the flat geometry (21 x 140 mm), combination with standard terrace decking boards or porcelain stoneware slabs is possible. Furthermore, the assembly height prescribed by the standard can be reduced to a height of 0.05 m.

DrainTec – drainage grate

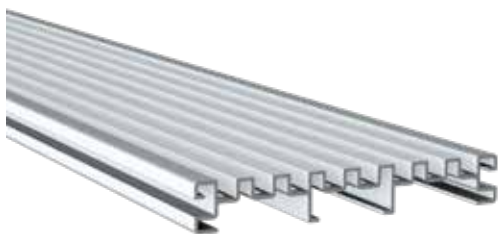

Art. no.	Name	Dimensions [mm] ¹⁾	Material	PU
975634	DrainTec – drainage grate	21 x 140 x 4000	Aluminium	1
975840	DrainTec – Aluminium drainage grate	21 x 100 x 4000	Aluminium	1

¹⁾ Height x width x length

ADVANTAGES

- Can be combined with the Eurotec product range to create elevated deck areas
- As an inspection and cleaning fitting
- Even for low door-joint heights
- For creating barrier-free, wheelchair-friendly transitions
- Also suitable for direct mounting on load-bearing foundations

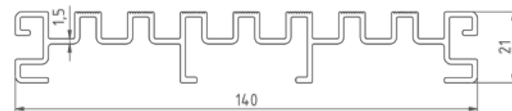

Draintec Clip



Art. no.	Name	Dimensions [mm] ¹⁾	Material	PU*
975635	DrainTec Clip	16,5 x 20 x 144	Stainless steel A2	2

¹⁾ Height x width x length

*Comes supplied with screws

Used to attach drainage grate by simply clicking into place and allows subsequent removal of drainage grate.



Without DrainTec the reflected rainwater splashes onto the door element or façade cladding.



With DrainTec the rain is drained off in a controlled manner and the rainwater flows directly into the foundation.



**THE AIM IS
CONTROLLED
WATER DRAINAGE.**

DRAINTEC BASE

The ideal addition to our DrainTec Drainage Grate

Thanks to the DrainTec Base, our DrainTec Drainage Grate can now also be used at ground level on gravel, sand and other substrates. Through the angular perforations in the middle of the base, the base can be combined with our adjustable pedestals from the PRO-Line series. The Click Adapter 60 is required for this. By using an additional screw, the base can be fixed onto the adjustable pedestal. The base can be used as part of standalone support and with aluminium substructures.

Draintec Base



Art. no.	Name	Dimensions [mm] ¹⁾	Material	PU
975658	DrainTec Base	20 x 144 x 2400	Aluminium	1

¹⁾ Height x width x length

ADVANTAGES

- Easy to clean base
- Does not require any additional substructure when laying on bulk material
- Compatible with classic substructures made of wood as well as with our modern aluminium system profile and the deck support system HKP
- Easy to lay
- Weather-resistant
- Compatible with adjustable pedestals PRO S – PRO XL

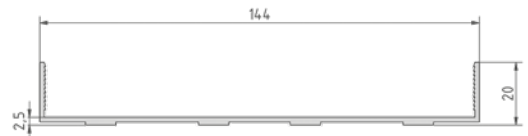

INSTRUCTIONS FOR USE

When using on an aluminium substructure we strongly recommend the use of our MaTre band (art. no. 945319). This serves to prevent noise when treading on the structure.



DrainTec Base in combination with the DrainTec drainage grate and PRO adjustable feet with click adapter.



DrainTec Base in combination with the DrainTec drainage grate without substructure.

DRAINTEC ADAPTER

The DrainTec Adapter is a special accessory for the DrainTec Base. This permits another stone slab to be laid on the base instead of our DrainTec drainage grid. The adapter is inserted on top of the DrainTec Base and then sits firmly on the profile. The adapter can receive one stone slab or alternatively two stone slabs butted together, with the centre spacers of the adapter providing an even pattern of joints. The width of the stone slab needs to be 114 ± 0.5 mm in order to create a joint on the sides through which water can run off and be drained away in a controlled manner using the DrainTec Base.

Draintec Adapter



Art. no.	Material	Dimensions [mm] ^{a)}	PU*
975626	Polypropylene-copolymer (PPC)	17,5 x 40,4 x 140,7	10

^{a)} Height x width x length

*For fastening, we recommend using Biglity PH drilling screws (954068). These are not included in the product.

ADVANTAGES

- Two attachment points enable the adapter to be fixed to the DrainTec Base.
- If DrainTec Base is attached to one of our PRO S – XL adjustable pedestals, the inserted stone slab can be adjusted to the level of the stone slabs of the terrace



Side view of the DrainTec adapter under a stone terrace.



The Draintec adapter allows rainwater to drain away in a controlled manner, with additional back ventilation arising at many detailed points.

DECK FASCIA BOARD MOUNT

The perfect accompaniment to our adjustable pedestals

The Eurotec deck fascia board mount can be used with the PRO M and L adjustable pedestals. It was developed to allow users to create a visually attractive border on decking. The deck fascia board mount consists of a base plate and a side bracket. For assembly purposes, the side bracket can be separated into two individual parts: the Clip and the Fix-Clip.

Deck fascia board mount

Set incl. base plate, side bracket and screws

Art. no.	Set consists of	PU*
946068	Base plate and Two-part side bracket	16

*Comes supplied with screws

ADVANTAGES

- For visually appealing edging
- Can be used with PRO M and L adjustable pedestals

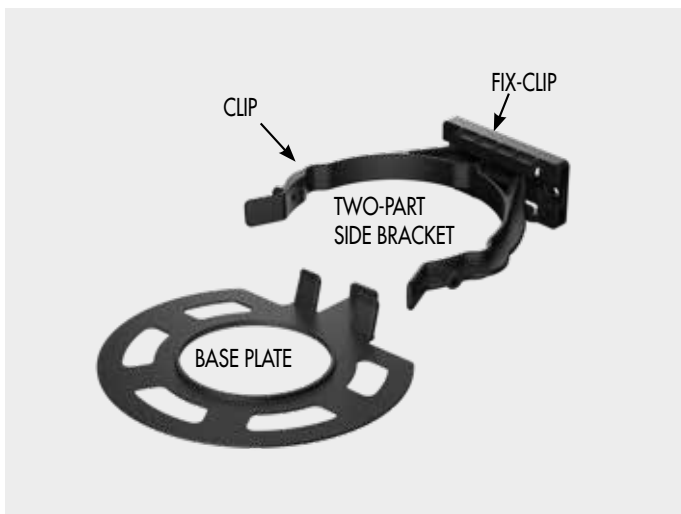

Application example for fastening a panel holder to a timber terrace with PRO L adjustable foot



Fastening a timber panel with the timber holder.

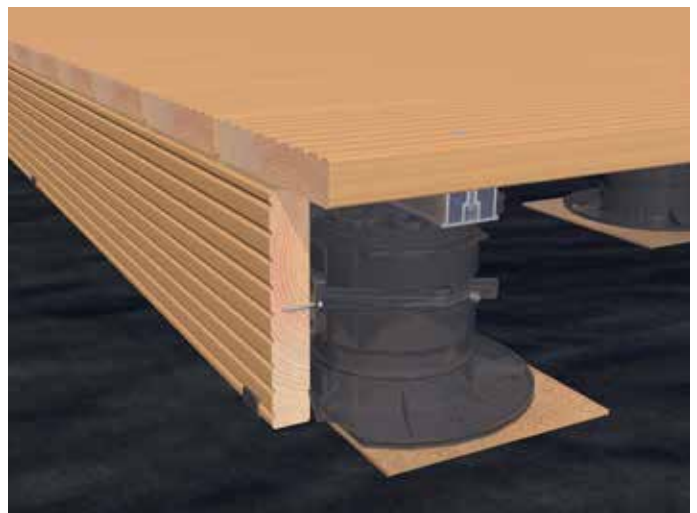

Visually appealing edging thanks to panel holder.



ACCESSORIES FOR HIDDEN FASTENING OF TERRACE DECKING BOARDS

ACCESSORIES FOR HIDDEN FASTENING FIXING THE DECK WITHOUT VISIBLE SCREW HEADS

Deck boards can be fastened in different ways, depending on the type of wood. We provide **innovative solutions** that enable your **individual requirements and wishes** for fastening your deck boards.

ADVANTAGES

- Indirect/hidden fastening solution
- Compatible with different Eurotec aluminium system profiles
- Uniform joint spacing is guaranteed
- Supports constructive timber protection
- Weather-resistant

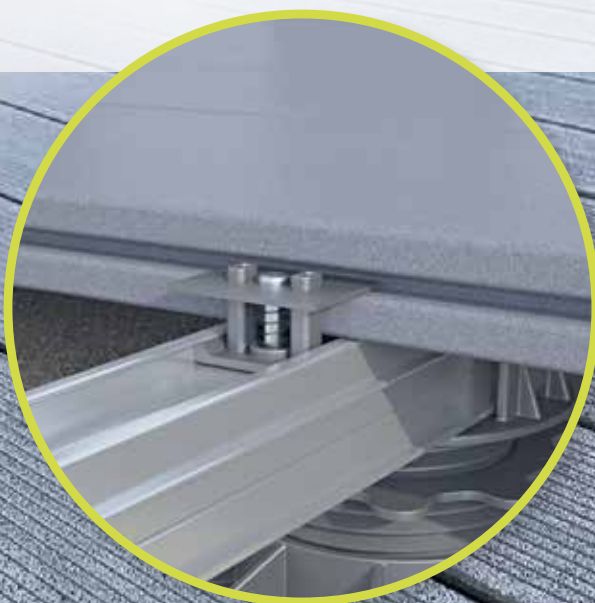

TWIN SYSTEM CLIP

Hidden fastening to aluminium substructure

The Twin aluminium system clip is **inserted between two wooden boards** before being secured within the board groove using a stainless steel clamping plate. The clamping plate is attached to the aluminium substructure using a drilling screw between the joints. The spacer domes **ensure uniform joint** spacing from board to board.

Twin system clip

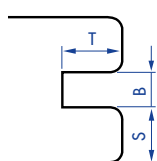

Art. no.	Dimensions [mm] ^{a)}	Material	PU*
945959	26 x 55 x 15	Plastic, black	200
Clamping plate	2 x 30 x 20,5	Stainless steel A2, black	

^{a)} Height x length x width

*Comes supplied with screw Ø 5 x 35 mm and bit



ADVANTAGES

- Indirect / hidden fastening solution
- Individual boards can be adjusted and replaced at any time
- Compatible with Eurotec's EVO/EVO Slim aluminium system profiles and the HKP deck-support system
- Uniform joint spacing of approx. 6 mm
- Supports constructive timber protection
- Weather-resistant

The Twin system clip is suitable for boards with the following groove geometry:

Groove depth, D:	Groove width, W:	Groove wall thickness, T:
≥ 7,5 mm	≥ 2,0 mm	≥ 2,0 – 12,0 mm

Where applicable, the manufacturer / timber supplier must establish whether the timber type is suitable.



ASSEMBLY INSTRUCTIONS

Note

If the Twin system clip is intended to be used in combination with the **Aluminium System Profile EVO Slim**, a shorter screw needs to be ordered separately. When the supplied screw Ø 5 x 50 mm is used there is the risk, that components below the EVO Slim, such as waterproofings, may get damaged.

It is necessary to take a look at our product data sheet available on www.eurotec.team/en or to get in contact with our technical support.

ALTERNATIVE SCREW FOR THE USE OF THE EVO SLIM PROFILE:

Art. no.	Dimensions [mm] ^{a)}	Groove wall thickness [mm]	Material	PU
111882	5 x 30	2,0 – 7,0	Stainless steel, hardened	100
111878	5 x 35	2,0 – 12,0	Stainless steel, hardened	100

^{a)} Height x length x width

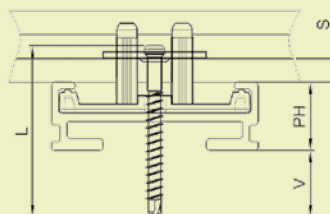

Concealed fastening of a timber board with Twin system holder.

EVO LIGHT SYSTEM CLIP

Hidden fastening to aluminium substructure

EVO Light system clip

Straight

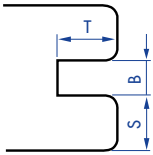

Art. no.	Dimensions [mm] ^{a)}	Material	PU*
946029	21 x 24 x 15	Plastic, black	200
Clamping plate	1,5 x 30 x 22	Stainless steel A2	

^{a)} Height x length x width
* Comes supplied with screw.



Note

In case of deviations of the groove thickness, the screw length may change!
Please contact our technical department.

EVO Light system clip, straight is suitable for boards with the following groove geometry:

Groove depth, D:	Groove width, W:	Groove wall thickness, T:
≥ 7,5 mm	≥ 2,0 mm	≥ 2,0 - 9,0 mm

Where applicable, the manufacturer/timber supplier must establish whether the timber type is suitable.

EVO Light system clip

Bent

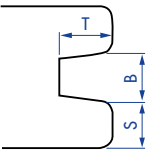

Art. no.	Dimensions [mm] ^{a)}	Material	PU*
946034	21 x 24 x 15	Plastic, black	200
Clamping plate	1,5 x 30 x 21,1	Stainless steel A2	

^{a)} Height x length x width
* Comes supplied with screw



Note

In case of deviations of the groove thickness, the screw length may change!
Please contact our technical department.

EVO Light system clip, bent is suitable for boards with the following groove geometry:

Groove depth, D:	Groove width, W:	Groove wall thickness, T:
≥ 7,5 mm	≥ 2,0 mm	≥ 2,0 - 9,0 mm

Where applicable, the manufacturer/timber supplier must establish whether the timber type is suitable.

ADVANTAGES

- For invisible attachment of grooved boards on: EVO Light aluminium system profile
- For questions regarding groove geometry, always contact your local specialist timber dealer
- Time-saving and easy installation
- Automatically predefined joint spacing of 6 mm
- Individual boards can be adjusted or replaced at any time
- Supports constructive timber protection
- Weather-resistant



Hidden fastening using EVO Light system clip

Groove Clip, M-Clip

Hidden fastening of deck boards

Groove Clip



Art. no.	Dimensions [mm] ^{a)}	Material	PU
954046	19,8 x 45 x 27	Polypropylene-copolymer (PP-C), black	100

^{a)} Height x length x width

The Eurotec groove clip is used for the invisible fastening of laterally grooved terrace decking boards made of low-movement wood on an wooden substructure. The clip is only suitable for grooves with a radius of 7 mm.

ADVANTAGES

- Quick and easy assembly
- Suitable for boards with a lateral groove
- Boards with a groove can easily be replaced

INSTALLATION INSTRUCTIONS

Prior to installation, it is important to enquire with your board manufacturer whether the board to be installed has the desired groove geometry.

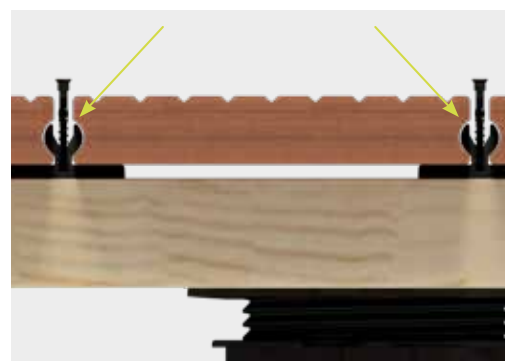

The groove clip (K) on a wooden substructure.*

*In this view, the screw is not completely screwed into the substructure. After completely screwing in, the screw is no longer visible and closes at the upper edge of the groove clip.

M-Clip

For Eveco aluminium system profiles



Art. no.	Dimensions [mm] ^{a)}	Material	PU*
111896*	10,75 x 23,6 x 40	Edelstahl, black	200

^{a)} Height x length x width

*Comes supplied with screw



The M-Clip can be used to fasten laterally grooved floorboards to our Eveco aluminium system profile or alternatively to a wooden substructure. Only low-movement wood types or WPC floorboards are suitable for concealed installation with the M-Clip.

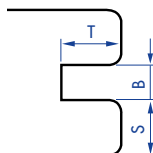

The M-Clip is suitable for boards with the following groove geometry:

Groove depth, D:	Groove width, W:	Groove wall thickness, T:
≥ 8,0 mm	≥ 4,5 mm	≥ 6,0 – 9,0 mm

Where applicable, the manufacturer/timber supplier must establish whether the timber type is suitable.

ADVANTAGES

- Quick and easy installation
- Can be combined with a large range of side groove geometries
- Automatically creates a board spacing of 6 mm



Example of application M-Clip

DECK GLIDERS

Hidden fastening of deck boards

The deck glider also creates a 10 mm gap between the substructure and the deck boards to prevent shearing of the stainless steel screws, for use with low-swelling and low-shrinkage timbers (see p. 171). However, in contrast to Distance strips 2.0, the boards are fastened indirectly, i.e. screw heads cannot be seen on the surface of the deck. The gliders fulfill all criteria for fastening both wood and composite boards.

Deck glider



Art. no.	Dimensions [mm] ^{a)}	Bedarf* [Stück/10 m ²]	Material	PU
944830	10 x 190 x 20	123	Hard plastic	200

^{a)} Height x length x width

*Clearance of bearing beams = 600 mm, board width = 145 mm, Joint dimension = 5 mm (depending on type of timber). Please use decking multi angles or the StarterClip for the first and last bearing beams, and for the board butts.

Each deck glider includes 4 Thermofix screws made of hardened stainless steel. If required, you can additionally buy the glider screws in A2 or A4 stainless steel.

Mini deck glider



Art. no.	Dimensions [mm] ^{a)}	Quantity* [piece/10 m ²]	Material	PU
944767	10 x 140 x 14	200	Hard plastic	200

^{a)} Height x length x width

*Clearance of bearing beams = 500 mm, board width = 90 – 100 mm, Joint dimension = 5 mm (depending on type of timber). Please use decking multi angles or the StarterClip for the first and last bearing beams, and for the board butts.

Each Mini deck glider includes 3 Thermofix screws made of hardened stainless steel. If required, you can additionally buy the glider screws in A2 or A4 stainless steel.



Note

The Mini deck glider is used for narrow deck boards with a width of 90 to 100 mm.

Glider screw Stainless steel A4

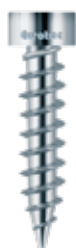

Suitable for this



Art. no.	Dimensions [mm]	Drive	PU
944927	4,2 x 24	TX20 ●	100

ADVANTAGES

- Limited resistance to acid
- Suitable for use with woods containing tanning agents such as cumarú, oak, merbau, robinia, etc.
- Suitable for saline atmospheres
- Not suitable for use in chlorous atmospheres

Thermofix screw

With drill point, stainless steel



Suitable for this



Art. no.	Dimensions [mm]	Drive	PU
945969	4,2 x 22	TX20 ●	100



INSTALLATION INSTRUCTIONS

To fasten the boards in place, the gliders are first screwed onto the underside of the boards and then screwed onto the substructure from above. This fastening type avoids direct connections to the substructure. The deck boards therefore have greater freedom of movement (via the deck glider).

Per glider, we recommend using two screws for fastening the glider onto the board and two screws for fastening the glider onto the substructure. For the Mini deck glider, you should use two screws for fastening the Mini deck glider onto the board and one screw for fastening it to the substructure. The deck gliders are suitable for boards with a width of 80 to 155 mm and a thickness of 20 to 30 mm. The Mini deck gliders are suitable for boards with a width of 90 mm to 100 mm and a minimum board thickness of 20* mm.

*If the 4,2 x 22 mm Thermofix screw is used



USING DECK GLIDERS



Fix the deck gliders to the underside of the boards, paying attention to the deck glider marking.



Slide the deck gliders under the boards in front. Use a spacer to achieve the perfect joint.



Fix the deck gliders into the substructure from above.

DECKING MULTI ANGLES / STARTERCLIP

Hidden screwing of start/end deck boards

Decking multi angles



Art. no.	Material	PU*
975584	Hard plastic	10

*40 system screws are included in the scope of delivery

Decking multi angles enable a clean and hidden conclusion when deck boards are laid.

ADVANTAGES

- Indirect/concealed fastening solution for edging
- Supports design-based wood preservation thanks to approx. 10 mm board distance from substructure.
- Weather-resistant



If you would like to fix the start/end decking without a visible screw, use the decking multi angle or the StarterClip.

StarterClip

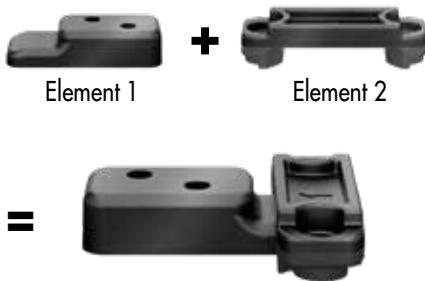

Art. no.	Material	PU*
975591	Hard plastic	10

*40 system screws are included in the scope of delivery

If decking multi angles cannot be used, e. g. because they cannot be screwed in from one side (house wall or brick-work), Eurotec has developed the StarterClip, which is the ideal solution in situations like this.

ADVANTAGES

- Indirect/concealed fastening solution for edging
- Supports design-based wood preservation thanks to approx. 10 mm board distance from substructure.
- Weather-resistant

USING THE STARTERCLIP



1 Fix element 2 of the StarterClip to the top of the terrace substructure.



2 Fix element 1 of the StarterClip to the bottom of the terrace decking board.



3 Insert element 1 into element 2. The terrace decking board is now fixed to the substructure.

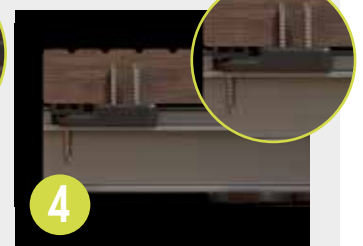

4 Done.

SNAP-IN FASTENER

Hidden screwing of start/end deck boards

The Eurotec snap-in fastener is used for the installation of start or end floorboards on a terrace with concealed screw connections. The fastener consists of two parts: the plug and the socket. The socket can be attached to the side of the substructure using the screws supplied. The snap-in function of the fastener covers a wide range of substructure assembly heights. All concealed Eurotec fastening solutions can be used to install the remaining floorboards.

Snap-in fastener

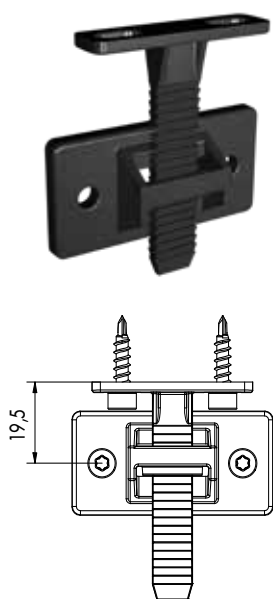

Art. no.	Dimensions [mm] ¹⁾	Material	PU*
975612	50 x 57,8 x 13	PP-C (Polypropylene-copolymer)	10

¹⁾ Length x width x height

*4 pc. Thermofix screws 4,2 x 17 mm are included in the scope of delivery.

ADVANTAGES

- Quick and easy installation of the start and end floorboards.
- Adjustment range from 19,5 – 45,5 mm*
- Can be used in combination with both a wooden and an aluminium substructure.
- Both laterally grooved and non-grooved floorboards can be fastened without any problems.

*The adjustment range is calculated from the distance between the upper web of the plug and the attachment point of the clip to the substructure.

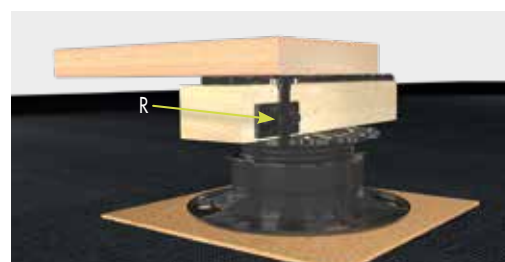

Fastening a wooden floorboard to a wooden substructure using the snap-in fastener (R).

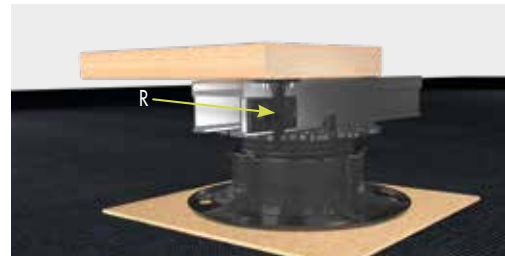

Fastening a wooden floorboard to the EVO aluminium system profile using the snap-in fastener (R).



The plug is fixed underneath the floorboard and can then be snapped into the socket.



DRILL TOOL 50X

The optimal screw-in aid

The drill tool 50X is a drilling jig for the invisible attachment of decking. Decking boards can only be fastened non-visibly with this tool. Thus, no screw heads are visible on the terrace surface.

The screws are evenly screwed in at a 50 ° angle thanks to the specified fixing points and thus optimally placed. The distance done on the drill tool 50X automatically ensures a uniform gap distance of 6 mm between the individual planks.

Drill Tool 50X



Attention

You need to ask the manufacturer or supplier whether the board is suitable for this type of attachment.

Art. no.	Dimensions [mm] ¹⁾	PU
499985	87 x 215 x 30	1

¹⁾ Height x length x width

ADVANTAGES

- Quick and easy decking installation
- Ensures a uniform joint pattern
- Fixing points are predefined
- Accessories for direct/concealed fastening of terrace decking boards



INSTRUCTIONS FOR USE

With the help of the drill tool 50X decking can be non-visibly fixed. For optimal installation without damaging the decking we recommend our 50X deck screw in A2 4,2 mm x 60 mm, 50X long-bit 82 mm TX15 and the 50X step drill 3,3 mm to 4,5 mm.



For decking thicknesses ≤ 21 mm and decking widths of 110 mm – 150 mm

The Drill Tool 50X on a wood panel with the 50X step drill and the 50X decking screw.

50X deck screw



Art. no.	Dimensions [mm]	Material	PU
905514	4,2 x 60	Stainless steel A2	250
100250	4,2 x 60	Stainless steel A4	250

50X long-bit

82 mm



Art. no.	Drive	PU
499985-Bit	TX15 •	1

50X step drill



Art. no.	Material	PU
499985-Bohrer	Carbide	1



T-STICK

Hidden fastening of deck boards

The T-Stick is inserted between two wood boards and fastened in the board groove with a steel plate. The result is an attractive wood surface without visible screw heads. The board clearance is maintained automatically by the T-Stick. The clearance of 9 mm to the substructure enables good ventilation, and this prevents waterlogging. The service life is therefore affected positively. If Eurotec's installation specifications are complied with, the T-Stick enables the boards to be adjusted easily before they are screwed down firmly. After fastening, the boards are absolutely firm. If a board has to be replaced, the system makes this possible even after the deck has been completed.

Quick installation

The T-Stick fastening system **can be used immediately**. Using the StarterClip allows **hidden screw connections even for the start and end boards**. No pilot drilling is needed.

Once the start board has been laid, the next board is put into position, aligned and fixed. Insert the T-Stick with the plate into the wood board groove, screw the screw in slightly to fix. After fixing the board, you can screw it in place.

Attention

Make sure that your cordless screwdriver's torque is set correctly so that you never over-tighten the screws.

T-Stick

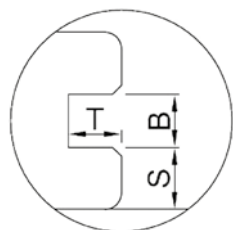

Art. no.	Edelstahl Platte*	Material	PU**
111857	A2	Plastic, black	125

*Stainless steel A4 plate available on request.

**Supplied with a drilling screw, which is suitable for wooden and aluminium substructures with a thickness of up to 3 mm.

ADVANTAGES

- Boards can be replaced easily even after the deck has been completed!
- Realigning individual boards is possible at any time.
- When they are fixed, the boards have a safe and firm seat.

MATERIAL DESCRIPTION

The T-Stick comprises a glass fibre reinforced, weather-resistant plastic cross with a stainless steel plate and a stainless steel screw.

The T-stick is suitable for planks with the following groove geometry:

Groove depth, D:	Groove width, W:	Groove wall thickness, T:
≥ 7,5 mm	≥ 2,5 mm	≥ 5,5 – 12,5 mm

Where applicable, the manufacturer/timber supplier must establish whether the timber type is suitable.

Note

Only suitable for dimensionally stable timbers and WPC. There are two design variants:

- 1) **Stainless steel A2 plate** for normal external use.
- 2) **Stainless steel A4 plate** for chlorous and saline atmospheres (e. g. seawater) and in woods with increased tanning acid content (e. g. Robinia, oak).

USING THE T-STICK

A WOOD DECK WITHOUT VISIBLE SCREW HEADS!



Start with the decking multi angle or StarterClip.



Align and fix the next board, screw down with the T-Stick until all boards are fastened.



The last board can then be fastened with the StarterClip.



This fastening system is suitable exclusively for deck boards with a side groove.

DECKING CLIP RI4

For non-visible fastening

The RI4 clip can be used to fasten laterally grooved boards to wooden substructures. The clip creates a uniform spacing 5 mm spacing between the boards. It is ideal for boards with a symmetrical groove, such as WPC or hardwood boards. Due to galvanization, the clip can be used in all 3 usage classes according to DIN EN 1995 (Eurocode 5).

Decking clip RI4

Hot-dip galvanised carbon steel



Service classes 1 – 3



Art. no.	Material	Accessories	PU
111800	DX51D + Z275	Panelwistec 1000 countersunk head screw 3,0 x 25 (Art. no. R903039)	200
* ¹ Height x length x width			

ADVANTAGES

- Indirect / invisible fastening solution
- Compatible with classic wooden substructures
- Uniform plank spacing of 5 mm
- Screws included in the package: 400x Panelwistec 1000 countersunk head 3.0 x 25 (Art. no.: R903039)



USING THE DECKING CLIP RI4 A WOODEN DECKING WITHOUT VISIBLE SCREW HEADS!



Fix the screws in the holes provided.

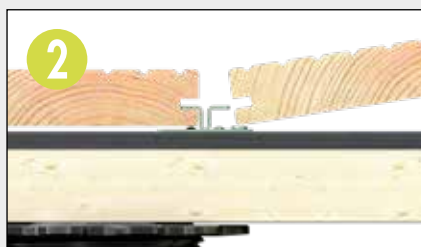

Fasten the wood in the RI4 Decking Clip so that both teeth are in contact with the milled groove in the board.

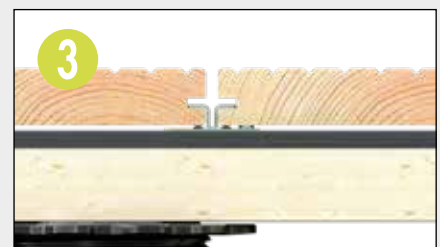

Fasten the boards with a clamp until the joint in the wood is 5 mm.

V-CLIP

Hidden fastening of deck boards

V-Clip

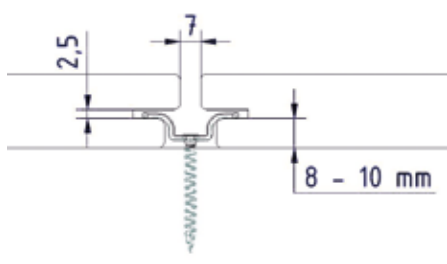

Art. no.	Dimensions [mm] ^{a)}	Material	PU*
111885	32,3 x 22,7 x 9,4	Stainless steel A2	250

^{a)}Length x width x height

*Comes supplied with screw Ø 4,2 x 25 mm and 1 Bit/PU

The stainless steel Eurotec V-Clip is suitable for the fastening of asymmetric grooved decking made of dimensionally stable timber types or WPC on timber substructures.

ADVANTAGES

- Indirect/hidden fastening solution
- Compatible with classic substructures made of wood as well as aluminium
- Uniform joint spacing of 7 mm

The V-Clip is suitable for planks with the following groove geometry:

Groove depth:	Groove width:	Groove wall thickness:
≥ 8,2 mm	≥ 2,5 mm	≥ 8,0 – 10,0 mm

Note

Only suitable for the fastening of asymmetric grooved decking made of dimensionally stable timber types or WPC.

Important

Make sure that your cordless screwdriver's torque is set correctly so that you never over-tighten the screws.



USING THE V-CLIP

A WOODEN TERRACE WITHOUT VISIBLE SCREW HEADS!



Position V-Clip and lightly fix with the 4,2 x 25 mm screw.



Insert additional boards and prepare with a joint of approx. 7mm (measured at the top edge).



Insert additional V-Clips and fix lightly – V-Clips positioned behind can now be tightened. Ensure that the tightening torque is set correctly!

ACCESSORIES FOR **VISIBLE FASTENING** OF TERRACE DECKING BOARDS

FIXING THE DECKING WITH VISIBLE SCREW HEADS

Deck boards can be fastened in different ways, depending on the type of wood. We provide innovative solutions that enable your individual requirements and wishes for fastening your deck boards.

ADVANTAGES

- Direct/visible fastening solution
- Easy, fast laying of the decking
- Compatible with different Eurotec aluminium system profiles
- Easy replacement of individual decking boards
- Supports constructive timber protection
- Weather-resistant

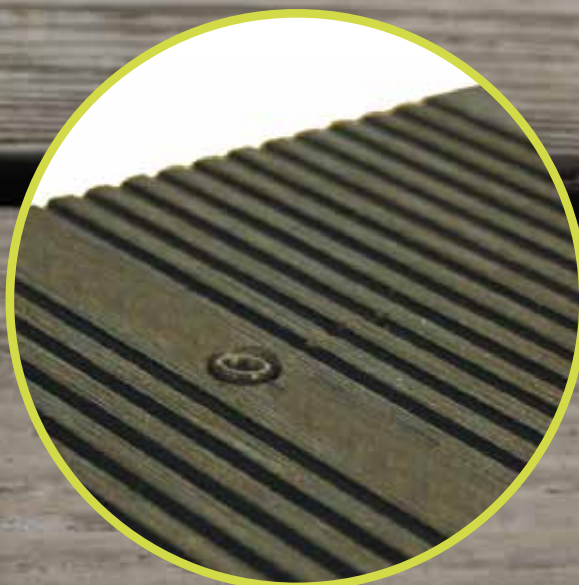

DISTANCE STRIP 2.0

Visible fastening of deck boards



Substructure: Timber

The wooden decking board substructure is individually suitable for visible or invisible attachments of the decking boards. Distance strip 2.0 is very well suited for visible attachments of decking boards. It works as a spacer and allows freedom of movement between panel and substructure. At the same time, it benefits the air circulation. Standard wood screws, such as Terrasotec screws, are used for the screw connection of a wood substructure. Distance strip 2.0 reduces the risk of sheared off screws.

Distance strip 2.0



Art. no.	Dimensions [mm] ^{a)}	Material	PU*
944803	7 x 30 x 700	Hard plastic	50

^{a)} Height x width x length

*Screws are not included.
Fastening with Terrasotec screws Ø 4 mm.



Distance strip 2.0 is attached and fixed with Terrasotec screws Ø 4 mm in the holes provided (5 Terrasotec screws are required for one Distance strip 2.0). Distance strip 2.0 is 70 cm long.

Important

Hardwoods/tropical woods should always be pilot-drilled!



Distance strip 2.0 on a timber structure



ASSEMBLY INSTRUCTIONS

Distance strip 2.0 reduces the risk of sheared off screws

Distance strip 2.0 is made of hard plastic and is intended to prevent the stainless steel screws from shearing off. The shearing is caused by the swelling and shrinking of the wood, the so-called working of the wood. This working of the wood is especially pronounced in the transverse direction of the boards. The wood „wants“ to take the screw with it, while the lower part of the screw is still firmly seated in the substructure. Since hard and tropical wood is very hard due to its very high density, the screw does not have a chance of pressing into the wood if the wood is working. If the screw breaks off due to this stress, this is called shearing off. Distance strip 2.0 was developed in order to prevent stainless steel

screws from shearing off. It creates a freedom of movement of 7 mm between substructure and decking boards, which gives the stainless steel screws the opportunity to move together with the wood.

What does „shearing off“ mean?

A screw can shear off (tear off) when it does not have enough freedom of movement while the wood is swelling and shrinking. With the help of Distance strip 2.0, a distance of 7 mm is achieved between the board and substructure, which allows the screws to adjust to the movements of the wood. In this way, shearing off is prevented.

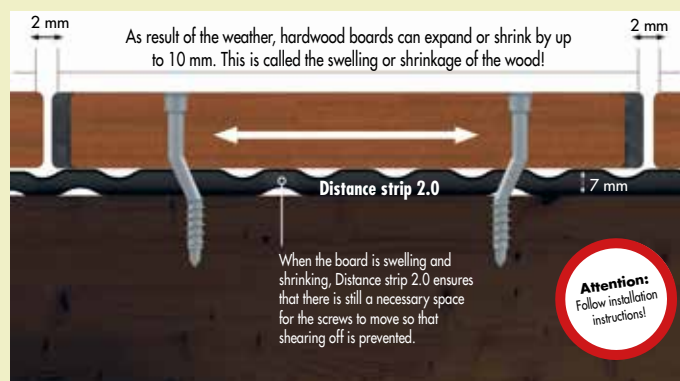
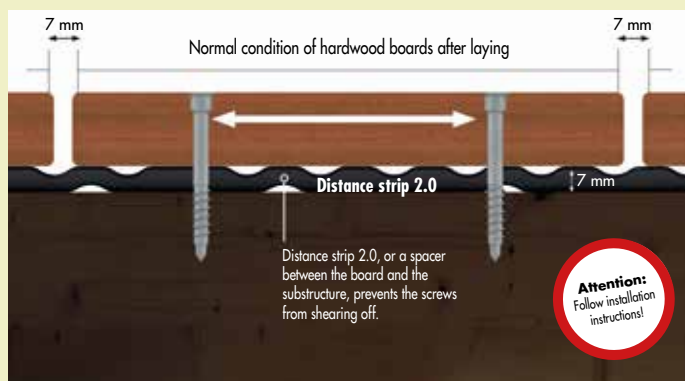

PROFILE DRILLING SCREW / WING-TIPPED PROFILE DRILLING SCREW

For visible fastening of deck boards

Suitable for Eurotec aluminium profiles, aluminium system profile EVO, EVO Light, HKP support profile and aluminium function strip..



Profile drilling screw

Stainless steel, hardened



Service classes 1 – 3



STAINLESS STEEL

Art. no.	Dimensions [mm]	Drive	Board thickness [mm]	PU
905553	5,5 x 41	TX25	16–20	200
905559	5,5 x 46	TX25	21–25	200
905559/RAL9005	5,5 x 46	TX25	21–25	200
905562	5,5 x 51	TX25	26–30	200
975797	5,5 x 56	TX25	30–36	200
905560	5,5 x 61	TX25	36–40	200

ADVANTAGES

- Limited resistance to acid
- 10 years experience without corrosion problems with suitable woods
- Not suitable for woods containing high amounts of tanning agents, such as cumarú, oak, merbau, robinia, etc.
- Not suitable for use in chlorous atmospheres
- Stainless steel in accordance with DIN 10088



Suitable for this:
Drill-Stop for Profile
drilling screw
Art. no.: 945606

Profile drilling screw

Stainless steel A4



Service classes 1 – 3

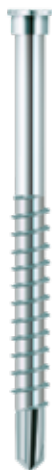

STAINLESS STEEL

Art. no.	Dimensions [mm]	Drive	Board thickness [mm]	PU
905571	5,5 x 41	TX25	16–20	200
905563	5,5 x 46	TX25	21–25	200
905564	5,5 x 51	TX25	26–30	200
975798	5,5 x 56	TX25	30–36	200
905565	5,5 x 61	TX25	36–40	200

ADVANTAGES

- Limited resistance to acid
- Suitable for use with woods containing tanning agents such as cumarú, oak, merbau, robinia, etc.
- Suitable for salty environments
- Not suitable for use in chlorous atmospheres



Note

The board should always be pilot-drilled to a diameter of 5,5 mm.



Suitable for this:
Drill-Stop for Profile
drilling screw
Art. no.: 945606

Wing-tipped profile drilling screw

Stainless steel, hardened



Service classes 1 – 3



STAINLESS STEEL

Art. no.	Dimensions [mm]	Drive	Board thickness [mm]	PU
905504	5.5 x 46	TX20	Max. 21	200
905505	5.5 x 51	TX20	Max. 26	200
905506	5.5 x 56	TX20	Max. 31	200

ADVANTAGES

- No pilot drilling into the decking board is necessary
- The clearing wings drill holes into the wood larger than the outer thread diameter of the screw
- Core hole and counter thread in aluminium are drilled and/or shaped independently
- Easy to screw in thanks to the TX drive and can be well combined with the TX20 magnetic bit holder

Note

The wing-tipped profile drilling screw has been specially developed for fastening timber decking to the aluminium system profile EVO and the support profile HKP for terraces. When using with other profiles and aluminium alloys, it is essential to check the functionality beforehand.



TERRASSOTEC TRILOBULAR / TERRASSOTEC / TRI-DECK-TEC



ADVANTAGES OF TERRASSOTEC TRILOBULAR

Special screw geometry

- Drive thread ensures quick screwing
- Reinforced shank reduces risk of breaking or shearing off
- Under-head thread provides additional hold for deck boards

Trilobular base geometry

- Reduced installation torque
- Reduced risk of screw breaking during screwing



Two-step head with under-head tothing

- Reduced splintering
- Reduced risk of timber splitting

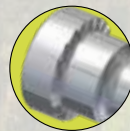

Reinforced shank

- Suitable for many tropical woods
- Reduced risk of screw shearing off

ADVANTAGES OF TERRASSOTEC

- Reduced splintering through special head
- With self-milling ribs for sinking easily in all wood types
- The screw geometry reduces the danger of splitting, but pilot drilling is recommended in particular for hardwoods and in deck and façade construction!

Check the information from the board manufacturer.



ON REQUEST, SCREW HEADS CAN BE
PAINTED IN RAL COLOURS.

TERRASOTEC ORNAMENTAL HEAD, CYLINDER HEAD

Terrasotec ornamental head A2

Austenitic high-grade steel A2

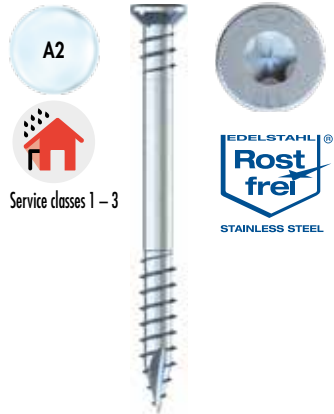

Art. no.	Dimensions [mm]	Drive	PU
975556	5,5 x 50	TX25 •	200
975556-EIMER	5,5 x 50	TX25 •	500
975557	5,5 x 60	TX25 •	200
975557-EIMER	5,5 x 60	TX25 •	500
975558	5,5 x 70	TX25 •	200
975559	5,5 x 80	TX25 •	200

ADVANTAGES

- Conditionally suitable for woods containing levels of tannin
- Corrosion-resistant and conditionally acid-resistant
- Good resistance in moderately aggressive environments that do not contain

Terrasotec ornamental head A4

Austenitic high-grade steel A4 1.4401



Art. no.	Dimensions [mm]	Drive	PU
982075-EIMER-200	5,5 x 50	TX25 •	200
982076-EIMER-200	5,5 x 60	TX25 •	200
982077-EIMER-200	5,5 x 70	TX25 •	200
982078-EIMER-200	5,5 x 80	TX25 •	200
982080-EIMER-200	5,5 x 100	TX25 •	200

ADVANTAGES

- Suitable for woods containing tannins and salty atmospheres
- Corrosion-resistant and conditionally acid-resistant
- Good resistance in moderately aggressive environments that do not contain

Terrassotec ornamental head

Stainless steel, hardened



Art. no.	Dimensions [mm]	Drive	PU
982065-EIMER-200	5,5 x 50*	TX25 •	200
982066-EIMER-200	5,5 x 60	TX25 •	200
982067-EIMER-200	5,5 x 70	TX25 •	200
982068-EIMER-200	5,5 x 80	TX25 •	200
982070-EIMER-200	5,5 x 100	TX25 •	200

*Not suitable for load-bearing purposes.

ADVANTAGES

- Not suitable for woods containing high levels of tannin, such as cumarú, poak, merbau, robinia, etc
- Not suitable for chlorinated atmospheres
- Stainless steel according to DIN 10088

Terrassotec cylinder head A2

Stainless steel A2

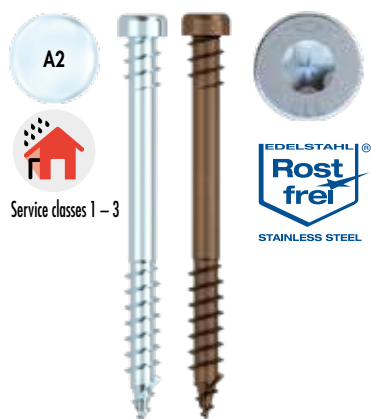

Art. no.	Dimensions [mm]	Drive	PU
975555	5,3 x 60	TX25 •	250
B975555	5,3 x 60	TX25 •	250
B975554 (antique)	5,3 x 50	TX25 •	250

ADVANTAGES

- Acid-resistant under certain circumstances
- Essentially corrosion-resistant
- Not suitable for chlorinated atmospheres

TERRASOTEC TRILOBULAR



Terrassotec Trilobular

Stainless steel, hardened



Art. no.	Dimensions [mm]	Drive	PU
905530	5,5 x 50	TX25 •	200
905529	5,5 x 60	TX25 •	200
905531	5,5 x 70	TX25 •	200
905538	5,5 x 80	TX25 •	200
905545	5,5 x 90	TX25 •	200
905546	5,5 x 100	TX25 •	200
905549*	5,5 x 120	TX25 •	200
905530-EIMER	5,5 x 50	TX25 •	500
905529-EIMER	5,5 x 60	TX25 •	500
905531-EIMER	5,5 x 70	TX25 •	500
905538-EIMER	5,5 x 80	TX25 •	500
905545-EIMER	5,5 x 90	TX25 •	500
905546-EIMER	5,5 x 100	TX25 •	500

* Also used to fasten 3D façades.

ADVANTAGES

- Essentially corrosion-resistant
- 10 years experience without corrosion problems with suitable woods
- Not suitable for woods containing high levels of tannin, such as cumarú, poak, merbau, robinia, etc
- Not suitable for chlorinated atmospheres
- Stainless steel according to DIN 10088

Terrassotec Trilobular

Stainless steel A2



Art. no.	Dimensions [mm]	Drive	PU
905539	5,5 x 50	TX25 •	200
905540	5,5 x 60	TX25 •	200
905541	5,5 x 70	TX25 •	200
905542	5,5 x 80	TX25 •	200
905539-EIMER	5,5 x 50	TX25 •	500
905540-EIMER	5,5 x 60	TX25 •	500
905541-EIMER	5,5 x 70	TX25 •	500
905542-EIMER	5,5 x 80	TX25 •	500

ADVANTAGES

- Only partially rust-resistant, not acid-resistant, relatively soft
- Not suitable for chlorinated atmospheres

Terrassotec Trilobular

Stainless steel A4



Art. no.	Dimensions [mm]	Drive	PU
905555	5,5 x 50	TX25 •	100
905556	5,5 x 60	TX25 •	100
905557	5,5 x 70	TX25 •	100
905558	5,5 x 80	TX25 •	100
905547*	5,5 x 90	TX25 •	100
905548	5,5 x 100	TX25 •	100
905555-EIMER	5,5 x 50	TX25 •	500
905556-EIMER	5,5 x 60	TX25 •	500
905557-EIMER	5,5 x 70	TX25 •	500
905558-EIMER	5,5 x 80	TX25 •	500

*The previous version will continue to be supplied until the switchover is complete.

ADVANTAGES

- Essentially corrosion-resistant
- Suitable for use with woods containing tanning agents such as cumarú, oak, merbau, robinia, etc.
- Suitable for saline atmospheres
- Not suitable for chlorinated atmospheres



ON REQUEST, SCREW HEADS CAN BE PAINTED IN RAL COLOURS.

Terrassotec Trilobular

Stainless steel, hardened, antique

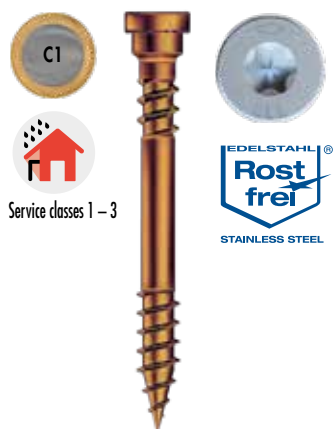

Art. no.	Dimensions [mm]	Drive	PU
B905530	5,5 x 50	TX25 •	200
B905529	5,5 x 60	TX25 •	200
B905531	5,5 x 70	TX25 •	200

ADVANTAGES

- Essentially corrosion-resistant
- 10 years experience without corrosion problems with suitable woods
- Not suitable for woods containing high levels of tannin, such as cumarú, poak, merbau, robinia, etc
- Not suitable for chlorinated atmospheres
- Stainless steel according to DIN 10088

TERRASSOTEC

Terrassotec
Stainless steel, hardened

Can be
combined with
EPDM
façade tape



Service classes 1 – 3



Art. no.	Dimensions [mm]	Drive	PU
905535	4,0 x 40	TX15 ●	500
905536	4,0 x 50	TX15 ●	500
905537	4,0 x 60	TX15 ●	500
945811	4,5 x 40	TX20 ●	200
905528	4,5 x 45	TX20 ●	200
905520	4,5 x 50	TX20 ●	200
905521	4,5 x 60	TX20 ●	200
905522	4,5 x 70	TX20 ●	200
905519	4,5 x 80	TX20 ●	200
905527	5,0 x 45	TX25 ●	200
905523	5,0 x 50	TX25 ●	200
905524	5,0 x 60	TX25 ●	200
905525	5,0 x 70	TX25 ●	200
905526	5,0 x 80	TX25 ●	200
905544	5,0 x 90	TX25 ●	200
905543	5,0 x 100	TX25 ●	200
905520-EIMER	4,5 x 50	TX20 ●	500
905523-EIMER	5,0 x 50	TX25 ●	500
905524-EIMER	5,0 x 60	TX25 ●	500
905525-EIMER	5,0 x 70	TX25 ●	500

ADVANTAGES

- Essentially corrosion-resistant
- 10 years experience without corrosion problems with suitable woods
- Not suitable for woods containing high levels of tannin, such as cumarú, poak, merbau, robinia, etc
- Not suitable for chlorinated atmospheres
- Stainless steel according to DIN 10088
- 50 % greater breaking torque than A2 and A4
- Magnetizable



ON REQUEST, SCREW HEADS CAN BE PAINTED IN RAL COLOURS.

PRACTICAL: Here's everything you need!

Terrassotec screws

Sales unit in bucket with 500 pieces



Incl. Drill-Stop



Incl. TX20 Bit



500
PCS.

TRI-DECK-TEC



Tri-Deck-Tec

Stainless steel, hardened



Service classes 1 – 3



Art. no.	Dimensions [mm]	Farbe	Drive	PU
905809	5,0 x 65	Blank	TX20 ●	200
BR905809-EIMER	5,0 x 65	Brown / NCS S 7010-Y50R	TX20 ●	250*
C905809-EIMER	5,0 x 65	Charcoal / NCS 8000-N matt	TX20 ●	250*
CR905809-EIMER	5,0 x 65	Cream / NCS 3010-Y30R matt	TX20 ●	250*
GR905809-EIMER	5,0 x 65	Grey / NCS 55500-N matt	TX20 ●	250*
OAK905809-EIMER	5,0 x 65	Oak / NCS S2050-Y30R matt	TX20 ●	250*
RW905809-EIMER	5,0 x 65	Redwood / NCS 5030-Y50R matt	TX20 ●	250*

*Supplied in a bucket incl. ECO drill stop and bit TX20.

ADVANTAGES

- Reduced risk of timber splitting
- Drive thread ensures quick screwing
- Under-head thread provides additional hold for deck boards
- Reduced splintering through special head
- Reduction of screw torque due to trilobular basic geometry
- Reduction of the risk of tearing off the screw when screwing through trilobular basic geometry



ON REQUEST, SCREW HEADS CAN BE PAINTED IN RAL COLOURS.



ASSEMBLY INSTRUCTIONS

EXPERT HINTS FOR THE CONSTRUCTION OF WOODEN TERRACES

WOOD DECK = PILOT-DRILLING

When building a wood deck using premium woods pilot-drilling and pre-counterboring is recommended in all circumstances. This applies to soft coniferous wood as well as to hardwood.



OUR HINT:
DRILL-STOP
PILOT DRILLING +
COUNTERSINKING

Drill-Stop for:

Terrasotec	Ø5 und 5,5 mm
Tri-Deck-Tec	Ø5 mm
Hapatec	Ø5 mm
Hapatec Heli	Ø5 mm

NO SPLINTERING, NO SHEARING!

By pre-drilling with the Drill-Stop and the especially developed head-shape of the Terrasotec and Tri-Deck-Tec screws, the risk of splintering is greatly reduced.



The screws can be prevented from shearing through the use of the Distance strip 2.0.



Splintering



Pilot-drilling + Terrasotec screw



HAPATEC PANEL FASTENER, ESPECIALLY FOR HARDWOOD



The Hapatec screw is made of hardened stainless steel and is a panel fastener, designed especially for hardwood. The screw has a scraping groove at the screw tip, milling ribs above the thread and a countersunk head. The Hapatec is also available in antique and black variants.

ADVANTAGES

- Essentially corrosion-resistant
- 10 years experience without corrosion problems with suitable woods
- Unsuitable for woods containing tannins such as cumarú, oak, intsia, robinia, etc.
- Not suitable for chlorinated atmospheres
- Stainless steel according to DIN 10088
- 50 % greater breaking torque than A2 and A4
- Magnetizable

NOW IN AVAILABLE IN
PRACTICAL BUCKETS OF
200 SCREWS OR MORE!



HAPATEC



Hapatec

Panel fastener hardwood, Stainless steel, hardened



Service classes 1 – 3



EDELSTAHL®
**Rost
frei**
STAINLESS STEEL

Art. no.	Dimensions [mm]	Drive	PU
111803	4,0 x 30	TX15 ●	500
111810	4,0 x 40	TX15 ●	500
111821	4,0 x 45	TX15 ●	500
111811	4,0 x 50	TX15 ●	500
111812	4,0 x 60	TX15 ●	500
904569	4,5 x 45	TX20 ●	200
111813	4,5 x 50	TX20 ●	200
111813/RAL7030*	4,5 x 50	TX20 ●	200
111814	4,5 x 60	TX20 ●	200
111815	4,5 x 70	TX20 ●	200
111816	4,5 x 80	TX20 ●	200
111816/RAL7030*	4,5 x 80	TX20 ●	200
100048	5,0 x 40	TX25 ●	200
100049	5,0 x 45	TX25 ●	200
111817	5,0 x 50	TX25 ●	200
111818	5,0 x 60	TX25 ●	200
111819	5,0 x 70	TX25 ●	200
111820	5,0 x 80	TX25 ●	200
111888	5,0 x 90	TX25 ●	200
111889	5,0 x 100	TX25 ●	200
904569-EIMER	4,5 x 45	TX20 ●	500
111813-EIMER	4,5 x 50	TX20 ●	500
111814-EIMER	4,5 x 60	TX20 ●	500
111815-EIMER	4,5 x 70	TX20 ●	500
111816-EIMER	4,5 x 80	TX20 ●	500
100048-EIMER	5,0 x 40	TX25 ●	500
111817-EIMER	5,0 x 50	TX25 ●	500
111817-200	5,0 x 50	TX25 ●	200
111818-EIMER	5,0 x 60	TX25 ●	500
111818-200	5,0 x 60	TX25 ●	200
111819-EIMER	5,0 x 70	TX25 ●	500
111819-200	5,0 x 70	TX25 ●	200
111820-EIMER	5,0 x 80	TX25 ●	500
111820-200	5,0 x 80	TX25 ●	200

* Painted head RAL7030

ON REQUEST, SCREW HEADS CAN BE
PAINTED IN RAL COLOURS

Hapatec black

Panel fastener hardwood, Stainless steel, hardened



Service classes 1 – 3



Art. no.	Dimensions [mm]	Drive	PU
111802/BLACK	4,0 x 35	TX15 ●	500
111810/BLACK	4,0 x 40	TX15 ●	500
111811/BLACK	4,0 x 50	TX15 ●	500
111812/BLACK	4,0 x 60	TX15 ●	500
111822/BLACK	4,5 x 40	TX20 ●	200
904569/BLACK	4,5 x 45	TX20 ●	200
111813/BLACK	4,5 x 50	TX20 ●	200
111814/BLACK	4,5 x 60	TX20 ●	200
111815/BLACK	4,5 x 70	TX20 ●	200
111817/BLACK	5,0 x 50	TX25 ●	200
111818/BLACK	5,0 x 60	TX25 ●	200
111819/BLACK	5,0 x 70	TX25 ●	200
111820/BLACK	5,0 x 80	TX25 ●	200
111889/BLACK	5,0 x 100	TX25 ●	200

ADVANTAGES

- Milling ribs enable easy countersinking for all types of wood
- The particular screw geometry decreases the risk of splitting the wood
- But pre-drilling is strongly recommended especially for hardwoods used in terrace and façade construction!
- Corrosion-resistant up to and including service class 3 – ‘freely exposed structures’ according to DIN EN 1995 (Eurocode 5)
- National and international certification
- No screw-hammering when screwed in with TX drive

NOW IN AVAILABLE IN
PRACTICAL BUCKETS OF
200 SCREWS OR MORE!

Art. no.	Dimensions [mm]	Drive	PU
111810-200-BLACK	4,0 x 40	TX15 ●	200
111811-200-BLACK	4,0 x 50	TX15 ●	200
111812-200-BLACK	4,0 x 60	TX15 ●	200
111813-200-BLACK	4,5 x 50	TX20 ●	200
111814-200-BLACK	4,5 x 60	TX20 ●	200
111815-200-BLACK	4,5 x 70	TX20 ●	200
111816-200-BLACK	4,5 x 80	TX20 ●	200
111817-200-BLACK	5,0 x 50	TX25 ●	200
111818-200-BLACK	5,0 x 60	TX25 ●	200
111819-200-BLACK	5,0 x 70	TX25 ●	200
111820-200-BLACK	5,0 x 80	TX25 ●	200



Hapatec »antique«

Panel fastener hardwood, Stainless steel, hardened



Art. no.	Dimensions [mm]	Drive	PU
B111817	5,0 x 50	TX25 •	200
B111818	5,0 x 60	TX25 •	200



Service classes 1 – 3



ADVANTAGES

- Essentially corrosion-resistant
- 10 years experience without corrosion problems with suitable woods
- Not suitable for woods containing high levels of tannin, such as cumarú, poak, merbau, robinia, etc
- Not suitable for chlorinated atmospheres
- Stainless steel according to DIN 10088
- 50 % greater breaking torque than A2 and A4
- Magnetizable

Hapatec Heli

Stainless steel A4



Art. no.	Dimensions [mm]	Drive	PU
100059	4,5 x 50	TX20 •	200
100059/BLACK	4,5 x 50	TX20 •	200
100055	4,5 x 60	TX20 •	200
100056	4,5 x 70	TX20 •	200
100057	4,5 x 80	TX20 •	200
100051	5,0 x 50	TX25 •	200
100052	5,0 x 60	TX25 •	200
100053	5,0 x 70	TX25 •	200
100054	5,0 x 80	TX25 •	200
100058	5,0 x 100	TX25 •	200
100051-EIMER-500	5,0 x 50	TX25 •	500
100052-EIMER-500	5,0 x 60	TX25 •	500
100053-EIMER-500	5,0 x 70	TX25 •	500
100054-EIMER-500	5,0 x 80	TX25 •	500

Can be
combined with
EPDM
façade tape

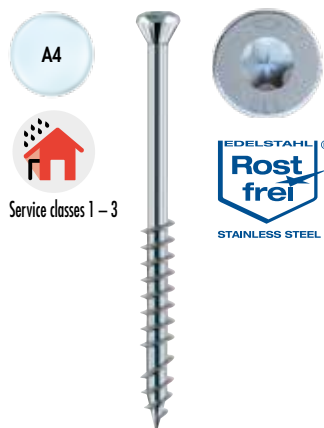

Service classes 1 – 3



The special screw geometry reduces the screwing torque. This reduces the danger of the shearing of the relatively soft A4 stainless steel screw.

ADVANTAGES

- Essentially corrosion-resistant
- Suitable for use with woods containing tanning agents such as cumarú, oak, merbau, robinia, etc.
- Suitable for saline atmospheres
- Not suitable for chlorinated atmospheres

Hapatec Heli

Stainless steel A2



Art. no.	Dimensions [mm]	Drive	PU
100060	5,0 x 50	TX25 •	200
100062	5,0 x 60	TX25 •	200
100060-EIMER-500	5,0 x 50	TX25 •	500
100062-EIMER-500	5,0 x 60	TX25 •	500

Can be
combined with
EPDM
façade tape



Service classes 1 – 3



ADVANTAGES

- Essentially corrosion-resistant
- Not suitable for chlorinated atmospheres



HOBOTEC

FOR CLEAN TIMBER-TO-TIMBER CONNECTIONS

Hobotec screws enable simple, fast and clean connections of wood to wood. These screws are used in particular in applications where there is an increased danger of cracking and splitting.

The type of thread and the innovative drill point enable a clean fit and high extraction resistance values.

SPECIALLY SUITABLE FOR

Applications in model construction, stairs construction, façade construction for carpentry work, joinery and roofing. These screws are used in particular in applications where there is a high risk of splitting. E. g. when laying wood floors, wood mouldings, etc.

APPLICATION RANGE FOR SCREWS MADE OF HARDENED STAINLESS STEEL:

- This steel combines the best properties of carbon and stainless steels. Conditionally rust-resistant like an A2 with the high mechanical values of a galvanised steel. Hardened stainless steel is not acid-resistant, which is why it is also not suitable for fastening wood containing tanning agents (e. g. oak).
- Hardened stainless steel can be magnetised
- Stainless steel in accordance with DIN 10088



Hobotec Countersunk head

Stainless steel, hardened

Can be combined with
EPDM
façade tape



For Ø 4,0 mm,
Ø 4,5 mm,
Ø 6,0 mm



Service classes 1 – 3



STAINLESS STEEL

ADVANTAGES

- No pilot drilling required
- No cracking or splitting in narrow edge areas
- No hammering of the screws through TX drive

Art. no.	Dimensions [mm]	Drive	PU
903323	4,0 x 30	TX15 ●	500
110299	4,0 x 40	TX15 ●	500
110300	4,0 x 45	TX15 ●	500
110301	4,0 x 50	TX15 ●	500
110302	4,0 x 60	TX15 ●	500
110319	4,5 x 40	TX20 ●	200
944839	4,5 x 45	TX20 ●	200
110303	4,5 x 50	TX20 ●	200
110304	4,5 x 60	TX20 ●	200
110305	4,5 x 70	TX20 ●	200
110306	4,5 x 80	TX20 ●	200
110307	5,0 x 50	TX25 ●	200
110308	5,0 x 60	TX25 ●	200
110309	5,0 x 70	TX25 ●	200
110310	5,0 x 80	TX25 ●	200
110311	5,0 x 90	TX25 ●	200
110312	5,0 x 100	TX25 ●	200
110313	6,0 x 80	TX25 ●	100
110314	6,0 x 90	TX25 ●	100
110315	6,0 x 100	TX25 ●	100
110316	6,0 x 120	TX25 ●	100
110317	6,0 x 140	TX25 ●	100
110318	6,0 x 160	TX25 ●	100

Hobotec ornamental head

Stainless steel, hardened

Can be combined with
EPDM
façade tape



For Ø 4,0 mm,
Ø 4,5 mm



Service classes 1 – 3



STAINLESS STEEL

APPLICATION

- Façades
- Fences
- Decks

Art. no.	Dimensions [mm]	Drive	PU
900782	3,2 x 25*	TX10 ○	500
110294	3,2 x 30	TX10 ○	500
110295	3,2 x 35	TX10 ○	500
110296	3,2 x 40	TX10 ○	500
110297	3,2 x 50	TX10 ○	500
110298	3,2 x 60	TX10 ○	500
945040	4,0 x 40	TX15 ●	500
945653	4,0 x 45	TX15 ●	500
945041	4,0 x 50	TX15 ●	500
945042	4,0 x 60	TX15 ●	500
945043	4,0 x 70	TX15 ●	500
945044	4,0 x 80	TX15 ●	500
945045	4,5 x 40	TX20 ●	200
945046	4,5 x 45	TX20 ●	200
945047	4,5 x 50	TX20 ●	200
945048	4,5 x 60	TX20 ●	200
945049	4,5 x 70	TX20 ●	200
945050	4,5 x 80	TX20 ●	200
945051	5,0 x 50/30	TX25 ●	200
945052	5,0 x 60/36	TX25 ●	200
945053	5,0 x 70/42	TX25 ●	200
945054	5,0 x 80/48	TX25 ●	200
945055	5,0 x 90/54	TX25 ●	200
945056	5,0 x 100/60	TX25 ●	200

*without milling ribs

The type of thread and the innovative drill point enable a clean fit and high extraction resistance values. Particularly suitable for brittle woods. Not suitable for tannin-rich woods such as cumarú, oak, merbau, robinia, etc.

HOBOTEC



Hobotec ornamental head

Stainless steel, hardened



Service classes 1 – 3

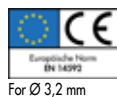

For Ø 3,2 mm

Art. no.	Dimensions Ød x L [mm]	Thread length lg [mm]	Head diameter Ødh [mm]	Drive	PU
110295/black	3,2 x 35	19	7,5	TX10 ○	500
110296/black	3,2 x 40	24	7,5	TX10 ○	500
110297/black	3,2 x 50	34	7,5	TX10 ○	500
110298/black	3,2 x 60	44	7,5	TX10 ○	500

Hobotec ornamental head

Steel yellow galvanised



Service classes 1 – 2



For Ø 3,2 mm,
Ø 4,2 mm

Art. no.	Dimensions [mm]	Drive	PU
110280	3,2 x 20*	TX10 ○	500
110281	3,2 x 25*	TX10 ○	500
110282	3,2 x 30	TX10 ○	500
110283	3,2 x 35	TX10 ○	500
110284	3,2 x 40	TX10 ○	500
110285	3,2 x 50	TX10 ○	500
110286	3,2 x 60	TX10 ○	500
944778	4,2 x 70	TX15 ●	200
944779	4,2 x 80	TX15 ●	200

*without milling ribs

Hobotec Countersunk head

Steel blue galvanised



Service classes 1 – 2



For \varnothing 4,0 mm,
 \varnothing 4,5 mm,
 \varnothing 6,0 mm

Art. no.	Dimensions $\varnothing d \times L$ [mm]	Thread length l_g [mm]	Head diameter $\varnothing dh$ [mm]	Drive	PU
111494	4,0 x 30	21	7,7	TX15 ●	1000
111495	4,0 x 35	24	7,7	TX15 ●	1000
111496	4,0 x 40	26	7,7	TX15 ●	1000
111497	4,0 x 45	28	7,7	TX15 ●	500
111498	4,0 x 50	30	7,7	TX15 ●	500
111499	4,0 x 60	36	7,7	TX15 ●	200
111501	4,5 x 35	24	8,7	TX20 ●	500
111502	4,5 x 40	26	8,7	TX20 ●	500
111503	4,5 x 45	28	8,7	TX20 ●	500
111504	4,5 x 50	30	8,7	TX20 ●	500
111505	4,5 x 60	36	8,7	TX20 ●	200
111506	4,5 x 70	42	8,7	TX20 ●	200
111507	5,0 x 40	26	9,7	TX25 ●	200
111508	5,0 x 50	30	9,7	TX25 ●	200
111509	5,0 x 60	36	9,7	TX25 ●	200
111510	5,0 x 70	42	9,7	TX25 ●	200
111511	5,0 x 80	48	9,7	TX25 ●	200
111512	5,0 x 90	54	9,7	TX25 ●	200
903623	5,0 x 100	60	9,7	TX25 ●	200
903117	6,0 x 80	48	11,7	TX25 ●	200
903118	6,0 x 90	54	11,7	TX25 ●	100
903119	6,0 x 100	60	11,7	TX25 ●	100
903120	6,0 x 120	60	11,7	TX25 ●	100
903121	6,0 x 140	70	11,7	TX25 ●	100
903122	6,0 x 160	70	11,7	TX25 ●	100

Hobotec ornamental head

Steel blue galvanised



Service classes 1 – 2



For \varnothing 3,2 mm

Art. no.	Dimensions $\varnothing d \times L$ [mm]	Thread length l_g [mm]	Head diameter $\varnothing dh$ [mm]	Drive	PU
110287	3,2 x 20*	Fully threaded	5,2	TX10 ○	500
110288	3,2 x 25*	Fully threaded	5,2	TX10 ○	500
110289	3,2 x 30	17,5	5,2	TX10 ○	500
110290	3,2 x 35	19	5,2	TX10 ○	500
110291	3,2 x 40	24	5,2	TX10 ○	500
110292	3,2 x 50	34	5,2	TX10 ○	500
110293	3,2 x 60	44	5,2	TX10 ○	500

*without milling ribs

MAMMUTEC

SUITABLE FOR STRONGER WOOD SURFACES

The Mammutec is specially designed for the attachment of stronger wooden flooring with a thickness of up to a maximum of 60 mm. The Mammutec screw can also be used in jetties and piers due to its high corrosion resistance.

ADVANTAGES

- Corrosion resistance
- Fixing of wood coverings with a thickness of up to 60 mm

APPLICATION INFORMATION

Pre-drilling and countersinking of 6 mm is absolutely necessary! This gives you space for the shaft. Due to the material thickness, there is always the risk of screw shearing due to shrinkage and swelling of the timber. This must be observed during assembly.

Art. no.	Dimensions [mm]	Drive	PU
905575	8,0 x 100	TX40 ●	50
905576	8,0 x 120	TX40 ●	50



Service classes 1 – 3

by Eurotec®



Tool Works

THE BEST TOOL FOR YOUR PROJECT

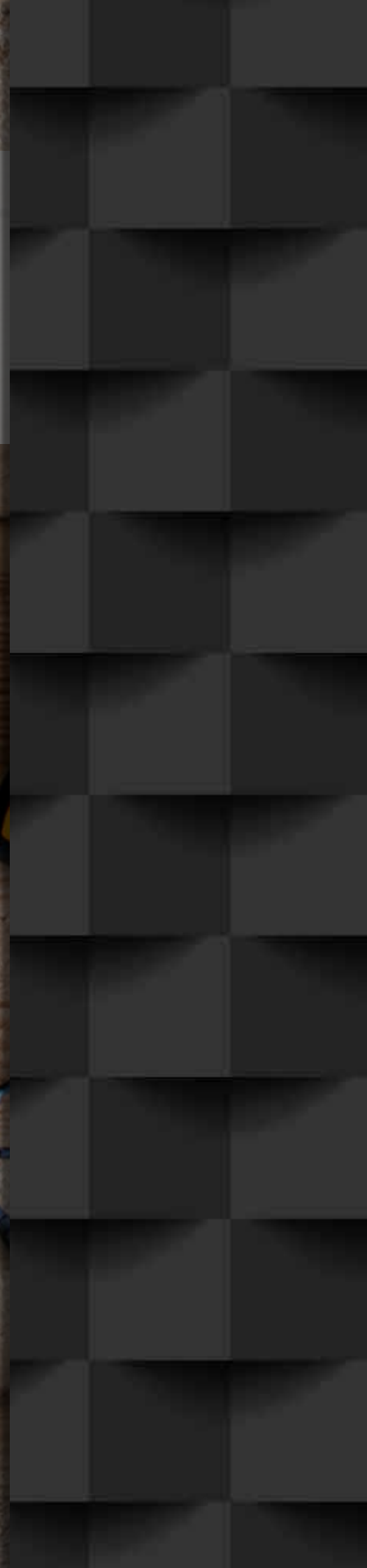

THE BEST TOOL FOR YOUR PROJECT

ToolWorks includes a variety of tools and products designed for timber constructions, interior designs and general craftsmanship.

Whether high-quality bits, combi lasers or spirit levels — the ToolWorks brand brings you high-quality products for any application — and all from a single source!

Our products are suitable for all kinds of applications and users — whether for DIYers, carpenters or architects.

**BROWSE THROUGH THE
ENTIRE BROCHURE NOW:**



BITS

The Eurotec bits consist of high-strength S2 steel, which considerably exceeds the hardness of conventional chrome-vanadium steel. Compared to conventional bits, our bits are therefore suitable for direct use in the impact screwdriver. Due to the CNC-milled head, the bits offer an especially firm hold in the screw drive and reduce slipping, hitting or tearing out during assembly. The black phosphating of the bits also ensures greater corrosion resistance. The integrated torsion zone absorbs tangential impact forces and prevents the bit from breaking. The additional laser engraving on the side of the bit is more durable than simple printing and allows for quick assignment and identification of drive size and type. It is easily possible to combine this with the Eurotec quick-release bit holder.



ADVANTAGES

- Reduces the knocking or tearing out of the screw during fitting
- Can be used with an impact wrench

Art. no.	Drive	Material	PU
101035	TX10	Galvanised steel as per DIN 3126	2
101036	TX15	Galvanised steel as per DIN 3126	2
101038	TX25	Galvanised steel as per DIN 3126	2
101039	TX30	Galvanised steel as per DIN 3126	2
101040	TX40	Galvanised steel as per DIN 3126	2
101001	TX10	Galvanised steel as per DIN 3126	5
101002	TX15	Galvanised steel as per DIN 3126	5
101003	TX20	Galvanised steel as per DIN 3126	5
101004	TX25	Galvanised steel as per DIN 3126	5
101005	TX30	Galvanised steel as per DIN 3126	5
101006	TX40	Galvanised steel as per DIN 3126	5
101029	PH1	Galvanised steel as per DIN 3126	2
101030	PH2	Galvanised steel as per DIN 3126	2
101031	PH3	Galvanised steel as per DIN 3126	2
101032	PZ1	Galvanised steel as per DIN 3126	2
101033	PZ2	Galvanised steel as per DIN 3126	2
101034	PZ3	Galvanised steel as per DIN 3126	2
100307	PH1	Galvanised steel as per DIN 3126	5
100308	PH2	Galvanised steel as per DIN 3126	5
100309	PH3	Galvanised steel as per DIN 3126	5
100310	PZ1	Galvanised steel as per DIN 3126	5
100312	PZ3	Galvanised steel as per DIN 3126	5



LONG BITS

The Eurotec long bits are suitable for use in hard-to-reach places such as between decking boards or for house cladding. This prevents damaging of the material by the drill chuck. By using high-strength S2 steel, the long bits can also be used with an impact screwdriver. The distinctive torsion zone absorbs tangential impact forces occurring during use, thereby preventing the bit from breaking. The precise CNC-milled head prevents the screw from slipping or hitting during assembly. Thanks to the black phosphating of the bits, they are characterised by increased corrosion resistance. The drive type and size can be quickly identified and assigned by clearly identifiable laser engraving on the side of the bits. It is possible to combine this with the Eurotec quick-release bit holder and the magnetic screw holder at any time. It is easily possible to combine this with the Eurotec quick-release bit holder.



ADVANTAGES

- Reduces the knocking or tearing out of the screw during fitting
- Can be used with an impact wrench

Art. no.	Drive	Material	PU
101007	TX10	Galvanised steel as per DIN 3126	2
101008	TX15	Galvanised steel as per DIN 3126	2
101010	TX25	Galvanised steel as per DIN 3126	2
101011	TX30	Galvanised steel as per DIN 3126	2
101013	TX10	Galvanised steel as per DIN 3126	5
101014	TX15	Galvanised steel as per DIN 3126	5
101015	TX20	Galvanised steel as per DIN 3126	5
101016	TX25	Galvanised steel as per DIN 3126	5
101017	TX30	Galvanised steel as per DIN 3126	5
101018	TX40	Galvanised steel as per DIN 3126	5
100313	PH1	Galvanised steel as per DIN 3126	2
100314	PH2	Galvanised steel as per DIN 3126	2
100315	PH3	Galvanised steel as per DIN 3126	2
100316	PZ1	Galvanised steel as per DIN 3126	2
100317	PZ2	Galvanised steel as per DIN 3126	2
100318	PZ3	Galvanised steel as per DIN 3126	2
100319	PH1	Galvanised steel as per DIN 3126	5
100320	PH2	Galvanised steel as per DIN 3126	5
100321	PH3	Galvanised steel as per DIN 3126	5
100322	PZ1	Galvanised steel as per DIN 3126	5
100323	PZ2	Galvanised steel as per DIN 3126	5
100324	PZ3	Galvanised steel as per DIN 3126	5



LONG BITS SET

The long bits set consists of 10 x 50 mm long bits as well as a magnetic screw holder in a practical storage box. The long bit in conjunction with the magnetic screw holder enables a strong hold on the screw head and prevents the screw from knocking while it is being screwed in. Thanks to the practical plastic clip, the storage box can be attached to a piece of clothing, ensuring it does not interfere with the assembly work.



1 x

10 x

ADVANTAGES

- Enables a strong hold on the screw head
- Reduces the knocking or tearing out of the screw during fitting
- Practical storage box

Art. no.	Included in delivery	Drive	Material	PU
100325	10 Bits, 1 Magnetic Screw Holder	PH1	Galvanised steel as per DIN 3126	11
100326	10 Bits, 1 Magnetic Screw Holder	PH2	Galvanised steel as per DIN 3126	11
100327	10 Bits, 1 Magnetic Screw Holder	PH3	Galvanised steel as per DIN 3126	11
100328	10 Bits, 1 Magnetic Screw Holder	PZ1	Galvanised steel as per DIN 3126	11
100329	10 Bits, 1 Magnetic Screw Holder	PZ2	Galvanised steel as per DIN 3126	11
100330	10 Bits, 1 Magnetic Screw Holder	PZ3	Galvanised steel as per DIN 3126	11
101020	10 Bits, 1 Magnetic Screw Holder	TX10	Galvanised steel as per DIN 3126	11
101022	10 Bits, 1 Magnetic Screw Holder	TX20	Galvanised steel as per DIN 3126	11
101023	10 Bits, 1 Magnetic Screw Holder	TX25	Galvanised steel as per DIN 3126	11
101024	10 Bits, 1 Magnetic Screw Holder	TX30	Galvanised steel as per DIN 3126	11
101025	10 Bits, 1 Magnetic Screw Holder	TX40	Galvanised steel as per DIN 3126	11

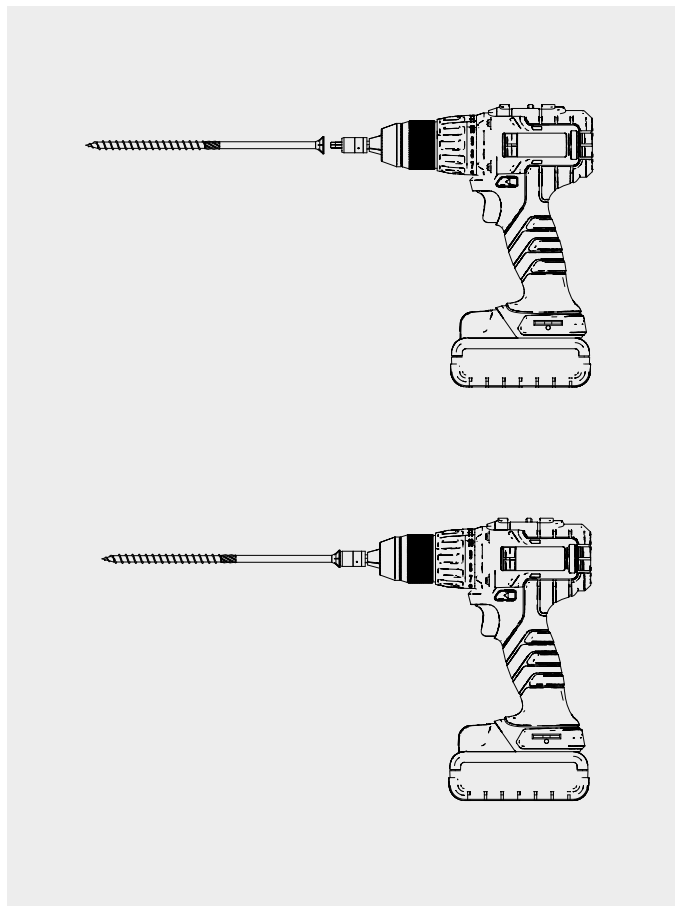

The magnetic screw holder provides a strong hold on the screw head.

MAGNETIC SCREW HOLDER

The Magnetic Screw Holder supports the fitting of screws. It is placed over the Long Bit that is already clamped and thus creates a larger magnetic contact surface for the screw head. Combined with our Long Bits, the Magnetic Screw Holder allows for the simple and uncompromising fitting of screws of all kinds.



Art. no.	Material	PU
101019	Galvanised steel as per DIN 3126	1

ADVANTAGES

- Suitable for all ToolWorks Long Bits
- Easy to use by simply placing it on the Long Bit

MAGNETIC SOCKET WRENCH INSERT

The magnetic socket wrench insert is ideal for assembling hexagonal screws. It may be easily clamped into the chuck of standard cordless screwdrivers or alternatively into a quick-change bit holder and then offers a firm hold. The magnet on the head of the socket wrench supports the hold on the screw head and makes fitting easier.



Art. no.	Head diameter [mm]	Material	PU
101026	6	Galvanised steel as per DIN 3126	1
101028	10	Galvanised steel as per DIN 3126	1

ADVANTAGES

- Easy and quick clamping in quick-change bit holders possible
- Perfect hold on hexagonal heads

AIDS FOR LAYING DECKING BOARDS

Bit dispenser box with TX Long Bits

Black



Art. no.	Drive	Content	PU
954102	TX20 ●	100	1
954103	TX25 ●	100	1
954104	TX30 ●	100	1
954105	TX40 ●	100	1

Bit dispenser box

A practical dispenser box with **100 x TX Long Bits** or **50 x Magnet TX Long Bits** in the sizes: TX20, TX25, TX30 or TX40.

The **magnet bits** provide an extremely strong hold and therefore prevent screws from falling. Even long screws remain securely held in place, even in a horizontal position.

The **TX Long Bit** is ideal for use in hard-to-reach places, e. g. deck boards, cladding, etc.

Bit dispenser box with Magnet TX Long Bits

Black



Art. no.	Drive	Content	PU
954106	TX20 ●	50	1
954107	TX25 ●	50	1
954108	TX30 ●	50	1
954109	TX40 ●	50	1

Bit holder



Art. no.	Length [mm]	PU
500011	66	1
500012	150	1
500013	500	1

Bit-Box

Specially made for wood construction



Art. no.	Content	PU
945857	5 x TX10 ○	1
	5 x TX15 ●	
	5 x TX20 ●	
	5 x TX25 ●	
	5 x TX30 ●	
	6 x TX40 ●	

1 x quick-change bit holder

31 TX bits and 1 quick-change bit holder in a practical box with a belt clip

Available to order individually or as a 10-pack incl. Sales display.

Universal Bit-Box

For universal applications



Art. no.	Description	PU
945858	<ul style="list-style-type: none"> ⊕ PH 1-1-2-2-3-3 ⊕ PZ 1-1-2-2-3-3 ○ Hex 4-4-5-5-6-6 □ Square 1-1-2-2-3-3 ⊗ TX 10-10-15-15-20-20-25-25-27-27-30-30 ⊗ SI-TX 10-10-15-15-20-20-25-25-27-27-30-30 1 x quick-change bit holder	1

48 bits and 1 quick-change bit holder in a practical box

Angled screwing attachment

For hard-to-reach locations

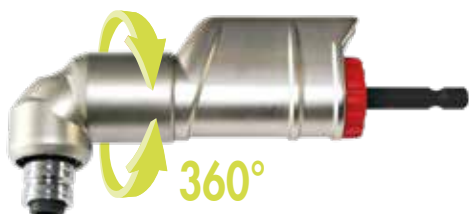

Art. no.	Description	PU*
499999	Angled screwing attachment	1

*Comes supplied with 1 bit each for TX20, TX25 and TX30





ADVANTAGES

- 90° Head angled at
- Compatible with all standard bits and machines
 - Magnetic 1/4" hexagonal bit holder
 - 1/4" hexagonal machine inputs
- Handle can be rotated and locked in 30° steps
- Suitable for clockwise and anti-clockwise rotation
- Maximum torque: 62 Nm
- Maximum speed of rotation: 2000 U/min

Stainless steel Long Bit

1/4" x 50 mm



Art. no.	Drive	Bit	PU
500055	TX10 ○		20
500056	TX15 ●		20
500057	TX20 ●		20
500058	TX25 ●		20
500059	TX30 ●		20

ADVANTAGES

- Protection against the risk of flash rust
- Avoidance of follow-up costs due to flash rust

Magnet TX Long Bit

1/4" x 50 mm



Art. no.	Drive	Bit	PU
499993	TX10 ○		5
499994	TX15 ●		5
499995	TX20 ●		5
499996	TX25 ●		5
499997	TX30 ●		5
499998	TX40 ●		5

The magnet bits from Eurotec provide an extremely strong hold and therefore prevent screws from falling. Even long screws remain securely in place, and even in a horizontal position.

ADVANTAGES

- Extremely strong hold in every position
- No falling screws

Magnet Bit Set



6 sizes in a blister pack.

Art. no.	Drive	PU
499992	TX10 ○ / TX15 ● / TX20 ● / TX25 ● / TX30 ● / TX40 ●	6

12in1 ratchet screwdriver



Art. no.	Dimensions [mm] ^{a)}	Weight [g]	PU
800490	250 x 35	265	1

^{a)}Length x width

ADVANTAGES

- Ratchet function - saves having to regripping
- 12 bits in the extendible clip
- Ergonomic and non-slip handle

TX-Bit

1/4" x 25 mm



Art. no.	Drive	Bit	PU
Length: 25 mm			
945851	TX10 ○		10
945852	TX15 ●		10
945853	TX20 ●		10
945854	TX25 ●		10
945855	TX30 ●		10
945856	TX40 ●		10

TX Long Bit

1/4" x 50 mm



Art. no.	Drive	Bit	PU
Length: 50 mm			
954666	TX10 ○		20
945975	TX15 ●		20
945976	TX20 ●		20
945977	TX25 ●		20
945978	TX30 ●		20
945979	TX40 ●		20
954658	TX50 ●		10

The long bit is suitable for use in hard-to-reach places, such as terrace boards, cladding and so on. It is suitable for use with common electric / battery-powered screwdrivers and can thus be used directly or with an adapter.

The long bit can be used for relatively inaccessible connections such as two wooden boards. Fixing is an absolute doddle, and no damage is caused to the boards by a drill chuck.

ADVANTAGES

- A firm hold in any position!

Art. no.	Description	PU*
945850	Quick-change bit holder	1

*Bit supplied separately

Eurotec's bit holder is an ideal auxiliary tool for any craftsman. Once the bit is inserted into the bit holder, it no longer falls out by itself.

Quick-change bit holder

Can be used for all 1/4" bits of any length



Tip: Simply connect 6 long bit packages (each containing 20 bits of one size) and you'll have a handy storage box.

Spacers

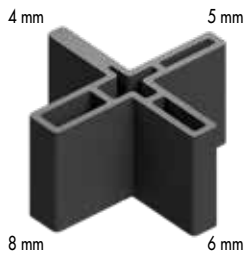

Art. no.	Dimensions [mm]	Material	PU
945381	42 x 22	Plastic, black	25

With this spacer, 4 different joint dimensions can be set when laying the boards (4, 5, 6 und 8 mm).



Anwendungsbeispiel Distanzklötzchen

Tenax spacer



Art. no.	Dimensions [mm]	Material	PU
945968	11 x 30 x 86	Plastic, black	300

If deck boards are to be screwed directly, ie visibly, the Tenax serves as a spacer to the underlay to prevent waterlogging in the joint. By placing the boards on top, the joint gap of 6 mm and the clearance to the substructure are set.

ADVANTAGES

- Optimum back ventilation
- Optimum clearance



Example of application spacers

Tension clamp

Incl. detachable plastic jaws

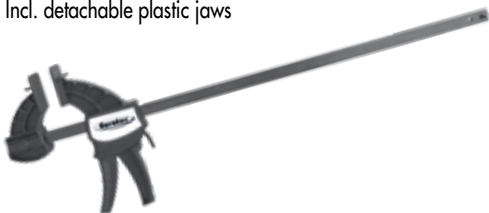

Art. no.	Dimensions [mm]	Material	PU
945380	270 x 830 x 55	Hard plastic/steel	1

The tension clamp is an essential aid for laying deck boards. Use at least 4 tension clamps to bring the boards into shape along their whole length. Along with the spacers, for example, this achieves an even joint pattern with straight deck boards.



Example of application tension clamp

Drill-Stop

Countersinking for deck screws



For Terrassotec Ø 5 und 5,5 mm,
Hapatec Ø 5 mm and
Hapatec Heli Ø 5 mm.

Art. no.	Dimensions [mm] ^{a)}	Material	Stopper collar	PU
945986	Ø 4,7 x 25	Hard plastic/steel	Orange	1

^{a)}Drilling diameter x drilling depth

Pilot drilling is strongly recommended for fastening tropical woods/hardwoods. This is advisable even with the relatively easily splittable Douglas fir, and when screwing close to wood cut against the grain.

ADVANTAGES / PROPERTIES

- Boring and countersinking in a single pass
- Screwing torque for inserting Terrassotec and Hapatec screws is greatly reduced, i. e. no more shearing of the screws, above all with the combination hardwood/stainless steel A2 or A4.
- Perfect seat of the screw head

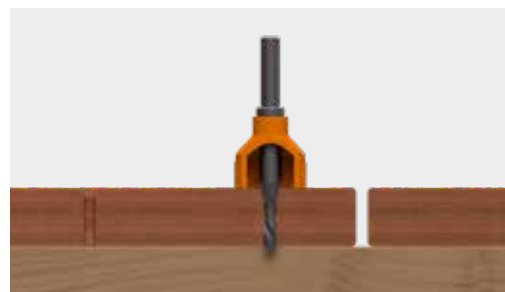

Example of application Drill-Stop

Drill-Stop for Profile drilling screw

Countersinking for Profile drilling screw



Art. no.	Dimensions [mm] ^{a)}	Material	Stopper collar	PU
945606	Ø 5,6 x 26	Hard plastic/steel	Blau	1

^{a)}Drilling diameter x drilling depth

Pilot drilling is strongly recommended for fastening tropical woods/hardwoods. This is advisable both for Douglas fir, which is relatively easy to split, and when screwing close to wood cut against the end grain.

ADVANTAGES / PROPERTIES

- Boring and countersinking in a single pass
- The screwing-in torque for inserting profile drilling screws is greatly reduced, i. e. no more screw shearing, particularly when combining hardwood and A2 or A4 stainless steel.
- Perfect seat of the screw head
- Optimised for the Eurotec 5,5 mm profile drilling screw

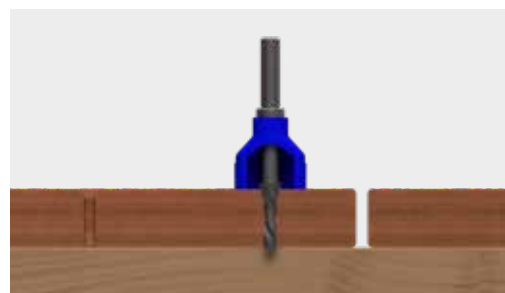

Example of application Drill-Stop for drilling screw

Screw Stop

Screw coupling with depth stopper



Art. no.	Dimensions [mm]	Material	PU*
500000	61,5 – 70 ; Ø 24	Hard plastic/steel	1

*Incl. TX25 Bit. The bit is locked in place by a lock washer and can be changed by using a pincer.

The Screw Stop is the ideal solution for driving screws to an even depth into the wood. In this way, your deck will be given an attractive, even surface pattern. You adjust the required screwing depth with the infinitely adjustable depth stopper. When this is reached, the drive uncouples and the screw stops. You do not have to start again to adjust the seat of the screw head.

ACCESSORIES FOR WOODEN FAÇADES

6



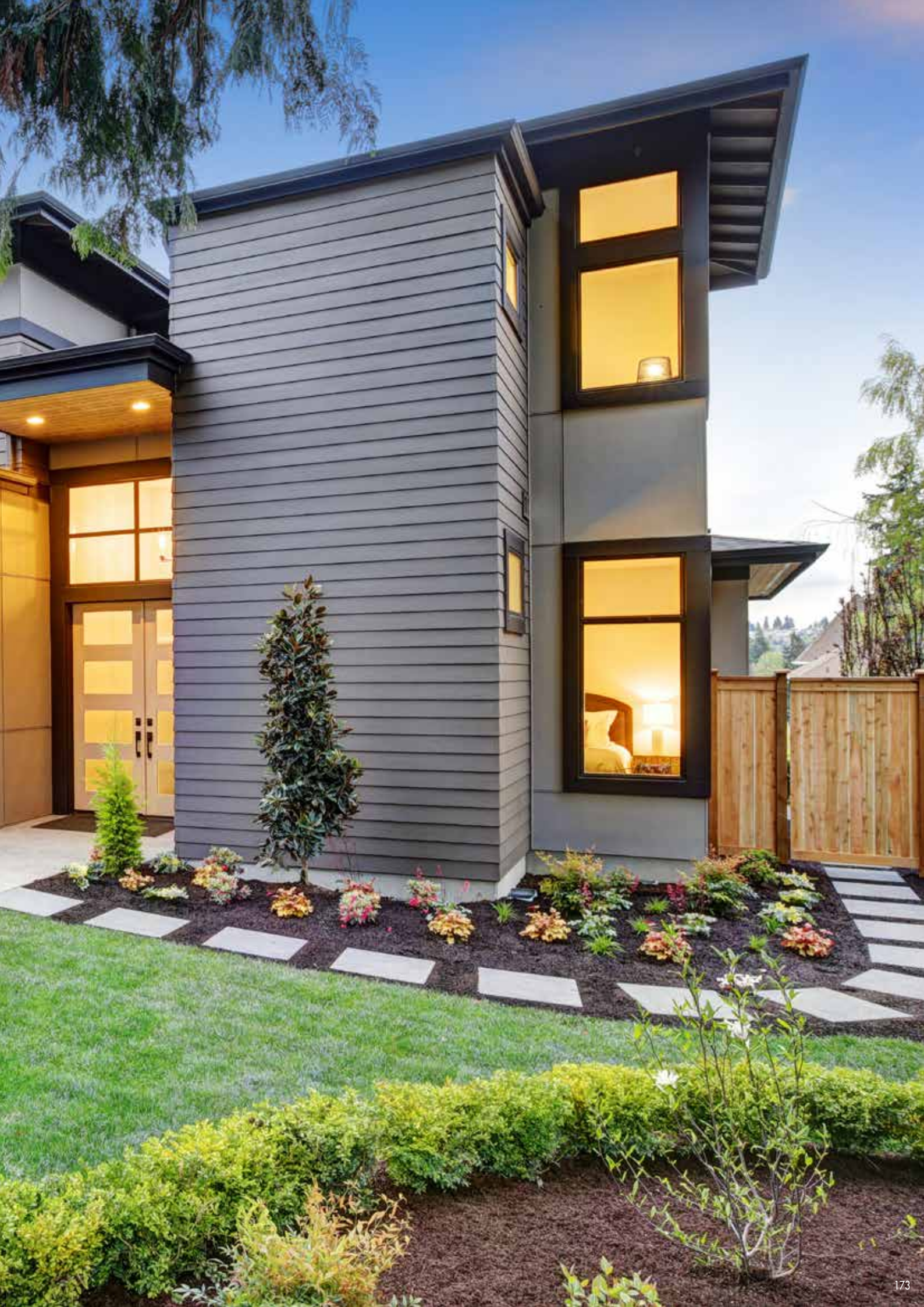

Façadeclip

For hidden fastening of façade wood

Façadeclip

Black, electrogalvanised



Art. no.	Dimensions [mm] ^{a)}	Type	PU*
946010	5,5 x 115 x 15	F115 x 17	300
946012	5,5 x 115 x 15	F115 x 22	300
946013	5,5 x 115 x 15	F115 x 28	300
946014	5,5 x 130 x 15	F130 x 17	300
946015	5,5 x 130 x 15	F130 x 22	300
946016	5,5 x 130 x 15	F130 x 28	300
946017	5,5 x 145 x 15	F145 x 17	300
946018	5,5 x 145 x 15	F145 x 22	300
946019	5,5 x 145 x 15	F145 x 28	300

^{a)}Height x length x width

*Screws are included with this product

ADVANTAGES

- For façade timbers with a profile height of 57 – 95 mm
- Hidden fastening
- Perfect constructive timber protection
- Ventilated façade system with spaced installation
- The façade timber's surface that is exposed to the weather remains undamaged
- Efficient and easy installation



Example of application Façadeclip

TECHNICAL DATA

Eurotec Façadeclip					Dimensions façade profile			Joint clearance between façade profiles		Quantity required Façade clips per m ² Example	
		Dimensions [mm]			min.-max. height	min. strength	Assembly screw Length L	Fixing screw in hole A	Fixing screw in hole B	min. profile height	max. profile height
Art. no.	Type	H	L	W	[mm]	[mm]	[mm]	[mm]	[mm]	Pieces	Pieces
946010	F115 x 17	5,5	115	15	57 – 68	19	17	10	variable	28	24
946012	F115 x 22	5,5	115	15	57 – 68	24	22	10	variable	28	24
946013	F115 x 28	5,5	115	15	57 – 68	30	28	10	variable	28	24
946014	F130 x 17	5,5	130	15	68 – 80	19	17	10	variable	24	20
946015	F130 x 22	5,5	130	15	68 – 80	24	22	10	variable	24	20
946016	F130 x 28	5,5	130	15	68 – 80	30	28	10	variable	24	20
946017	F145 x 17	5,5	145	15	80 – 95	19	17	10	variable	20	18
946018	F145 x 22	5,5	145	15	80 – 95	24	22	10	variable	20	18
946019	F145 x 28	5,5	145	15	80 – 95	30	28	10	variable	20	18

Fastened to substructure with 4,5 x 29 mm fixing screw with drill point

Formula for determining quantity
(1000 mm/substructure distance) x (1000 mm/bottom edge clearance) = pieces/m²

600 mm substructure clearance
10 mm joint clearance

Please note: Before any work is carried out, all calculations must be checked and released by the responsible planner! For more information on this visit our homepage: www.eurotec.team/en

USING THE FAÇADECLIP



Easy installation

- 1** Place Façadeclip on the back with stopper and insert assembly screws.
- 2** Repeat on all façade boards displaced.
- 3** Screw the façade wood to the counter-lathe with fixing screw.
- 4** Simply insert the next façade wood and screw on the top only with fixing screw.

- 5** The joint clearance is set automatically by the screw head of the fixing screw, that's it!

Each Façadeclip comes supplied with one 4,5 x 29 mm fixing screw with a drill point and two 4,2 x L assembly screws.

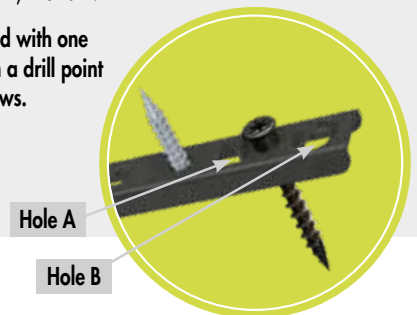

Façadeclip for Rhombus profiles

For use with the most common façade profiles

Façadeclip for Rhombus profiles

System consisting of a Façadeclip Rhombus Starter and a Façadeclip Rhombus

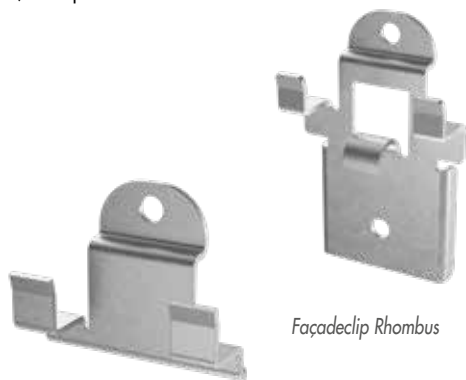

Façadeclip Rhombus

Façadeclip Rhombus Starter

Art. no.	Description	Dimensions [mm] ¹⁾	Material	PU*
944917-50	Façadeclip Rhombus	15,20 x 54,5 x 29,5	Galvanised steel	50
944917-200	Façadeclip Rhombus	15,20 x 54,5 x 29,5	Galvanised steel	200
944918	Façadeclip Rhombus Starter	15,25 x 29,5 x 36,0	Galvanised steel	25

¹⁾Height x length x width
*Incl. screws

Using the clip creates a joint dimension of 6 mm. The clip was designed so that it does not rest flat on the substructure, instead it elevates the boards by 4 mm from the substructure. The constructional wood protection allows for rear ventilation of the façade, which is not the case with any of the usual products. Rear ventilation results in better drying when the façade is exposed to rain, and water can run off between the clip and substructure. The constructional measures increase the façade's service life.

ADVANTAGES / PROPERTIES

- Optimised rear ventilation by constructive timber protection - Exclusive to Eurotec!
- Creates a distance between rhombus profile and substructure
→ effectively supports design-based wood preservation
- Invisible fastening
- Formation of fixed points and sliding points
- Easy installation
- Weather-resistant



Wall connection with rhombus façade clip

TECHNICAL DATA:

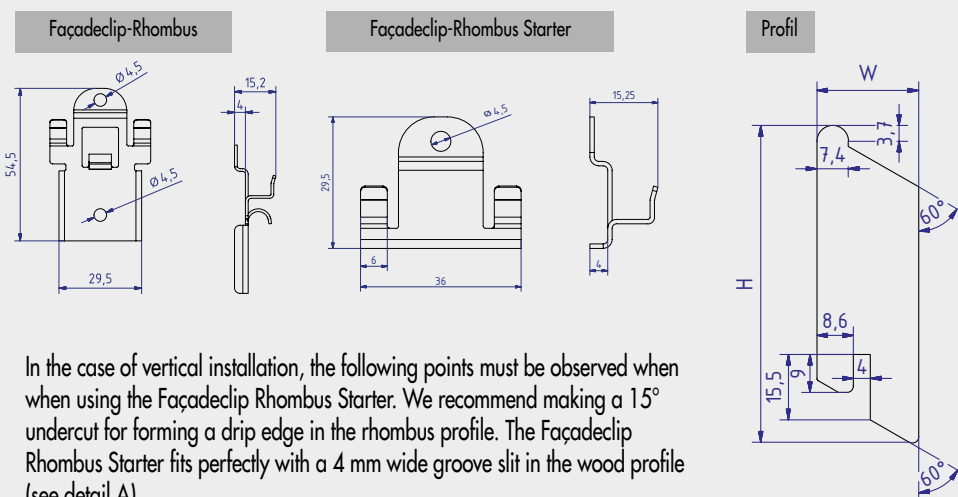

In the case of vertical installation, the following points must be observed when using the Façadeclip Rhombus Starter. We recommend making a 15° undercut for forming a drip edge in the rhombus profile. The Façadeclip Rhombus Starter fits perfectly with a 4 mm wide groove slit in the wood profile (see detail A).

PROPERTIES RHOMBUS PROFILES

- Dimensional stability must be provided for wood
- Low to moderate gross density
- Low swelling and shrinkage
- Suitable for wood that is low in tannin

DETAIL A



Variant	Dimensions	
	Height H [mm]	Width W [mm]
Variant 1	70	21
Variant 2	75	24

CONIFEROUS WOODS*



Larch



Douglas fir

THERMALLY MODIFIED TIMBER*



Thermo Pine



Thermo-Beech



Thermo Ash

*Other wood can also be used, but please ask your wood supplier..



FAÇADE FIXING SCREW ZK FOR THE NON-VISIBLE ATTACHMENT OF RHOMBUS PROFILES

ADVANTAGES

- Non-visible attachment
- Milling ribs enable easy countersinking for all types of wood
- Short thread for compact bolting to the substructure and the rhombus profile
- Corrosion-resistant up to and including service class 3 - "freely exposed constructions" according to DIN EN 1995 (Eurocode 5)
- The particular screw geometry decreases the risk of splitting the wood. Pre-drilling, however, is strongly recommended, in particular for hardwoods used for the façade construction!

Art. no.	Dimensions [mm]	Drive	PU
905577	5,5 x 40	TX25 •	200
905578	5,5 x 45	TX25 •	200
905579	5,5 x 50	TX25 •	200
905580	5,5 x 55	TX25 •	200
905581	5,5 x 60	TX25 •	200
905582	5,5 x 70	TX25 •	200
905583	5,5 x 80	TX25 •	200
905585	5,5 x 90	TX25 •	200
905584	5,5 x 100	TX25 •	200

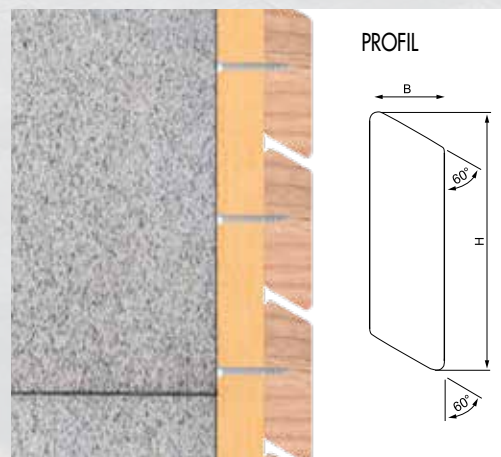

Wall connection with ZK façade screw



Service classes 1 – 3



ESPECIALLY
SHORT
THREAD
LENGTHS*

*For compact screwing of substructure and rhombus profile.

WOOD CONNECTORS AND FITTINGS

7







PEDIX POST FEET

QUICK TO ASSEMBLE, WITH AN ESPECIALLY HIGH LOAD-BEARING CAPACITY

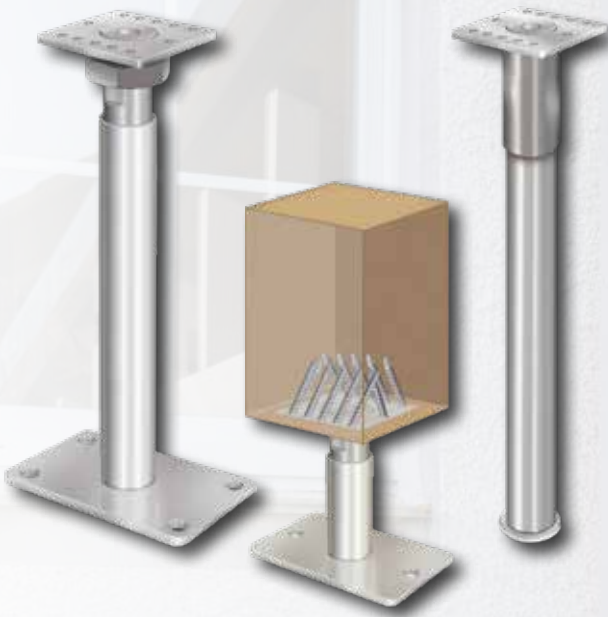

WHAT CAN IT BE USED FOR?

- For anchoring wooden posts of wooden structures onto concrete foundations
- Carports, canopies, patio roofs

ADVANTAGES

- Easy assembly without milling
- Subsequently adjustable in height up to 50, 100 and 150 mm
- The PediX 300 + 150 and the PediX 300 + 150 HV enable the increased demands on constructive wood preservation according to DIN 68800-2
- High load capacity according to ETA 13/0550
- Additional constructive timber protection thanks to gasket on end grain
- Min. timber cross section of 100 x 100 mm
- Hot-dip galvanised structural steel S235JR (ST37-2)
- Meets the requirements of constructive wood preservation, thus increasing the longevity of the wood construction (protection against splashing water)

INSTALLATION



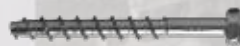





- Simple assembly with fully threaded screws and no need for joinery work, pilot-drilling or milling
- Comes supplied with 12 fully threaded A2 screws measuring 5,0 x 80 mm



Suitable for this: Rock concrete
screw hexagonal BIM A2
10,5 x 95 mm Art. no.:
110355



TECHNICAL DATA

Name	Art. no.	Height adjustment in assembled state	Min. post cross section	Dimensions of baseplate	Compressive loadbearing capacity	Tensile loadbearing capacity	Lateral force resistance ¹⁾	PU
Post feet on concrete		[mm]	[mm]	H x L x W [mm]	$N_{c,d}$ [kN]	$N_{t,d}$ [kN]	$V_{R,d}$ [kN]	pcs.
PediX 140+50 	904681	140 – 190	100 x 100	8 x 160 x 100	48,0	9,2	–	4
PediX 190+100 	904682	190 – 290	100 x 100	8 x 160 x 100	30,9	9,2	–	4
PediX 300+150 	904689	300 – 450	100 x 100	8 x 160 x 100	16,2	9,2	–	4
PediX 140+50 HV 	904681-HV	140 – 190	100 x 100	8 x 160 x 100	48,0	9,2	3,5	4
PediX 190+100 HV 	904682-HV	190 – 290	100 x 100	8 x 160 x 100	35,4	9,2	2,9	4
PediX 300+150 HV 	904689-HV	300 – 450	100 x 100	8 x 160 x 100	34,5	8,6	2,3	4
Post feet in concrete		Height adjustability [mm]	[mm]	H x L x W [mm]	$N_{c,d}$ [kN]	$N_{t,d}$ [kN]	$V_{R,d}$ [kN]	pcs.
PediX B500 	904683	–	100 x 100	–	49,0	24	4,6	4
PediX B500+50 	904686	50	100 x 100	–	44,9	23	–	4

¹⁾The lateral force resistance must be overlaid with the compressive and tensile load in accordance with ETA-13-/0550 and can therefore lead to lower load-bearing capacities.

Please note: The stated values are only intended as planning aids. They are subject to typographical and printing errors. Projects must only be calculated by authorised persons.



ASSEMBLY INSTRUCTIONS

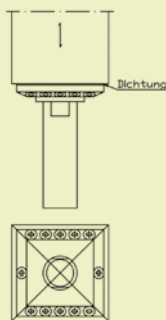

The PediX post foot can be attached easily to the end grain. Place the seal on the support foot and then place both parts centrally on the end grain surface.

Note: To make assembly easier, the base plate and the cover sleeve can be unscrewed.

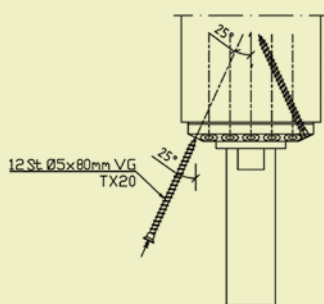

After centring the head plate, screw in the 12 A2 full-thread 5,0 x 80 mm screws at an angle of 25° without base plate.

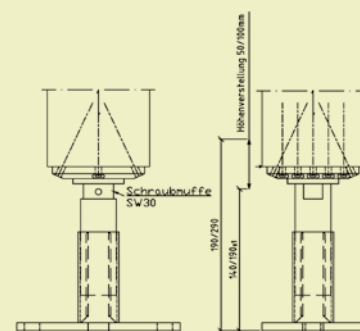

The protective sleeve and the pilot drilling can be reinstalled after all screws are fitted. After the post is erected with the post foot installed, it can be anchored on a concrete foundation with two or four cavity-wall ties or concrete bolts. Once the foot is installed on the socket, its height can be adjusted using an AF30 spanner.

Please note: Do not screw the post foot to a height greater than 190, 290 or 450 mm respectively.

PediX Easy 135+65 / 200+100

Horizontal loads can be supported additionally



The PediX Easy 135+65 and PediX Easy 200+100 are post supports for **lightweight timber structures** that meet structural wood preservation requirements. They can be assembled on the end grain **without any need for additional joinery work or pilot drilling** using fully threaded screws. **Following assembly, the height of the support pedestals can still be adjusted by 65 mm or 100 mm.** Thanks to the height adjustment, manufacturing tolerances relating to the structure and subsequent settlement in the individual foundations can be balanced out. The PediX Easy 135+65 and PediX Easy 200+100 can **also absorb horizontal loads**. The pedestal's durability is guaranteed by a **zinc/nickel coating**.

PediX Easy 135+65 / 200+100



Art. no.	Name	Dimensions of baseplate [mm] ^{a)}	Height adjustment in assembled state	PU*
904678	PediX Easy 135+65	160 x 100 x 6	135 – 200	4
904684	PediX Easy 200+100	160 x 100 x 6	200 – 300	4

^{a)}Length x width x height

*Delivery incl. twelve A2 fully threaded screws (Ø 5,0 x 80 mm) per post support.

ADVANTAGES / PROPERTIES

- Simple assembly with fully threaded screws and no need for joinery work, pilot-drilling or milling
- Min. timber cross section of 100 x 100 mm
- Can be used in the usage classes 1, 2 and 3 in accordance with DIN EN 1995-1-1
- Horizontal loads can be supported additionally

Name	Art. no.	Height adjustment in assembled state	Dimensions of baseplate	Compressive loadbearing capacity	Tensile loadbearing capacity	Lateral force resistance ¹⁾	PU
Post feet on concrete		[mm]	H x L x W [mm]	N _{c,d} [kN]	N _{t,d} [kN]	V _{e,d} [kN]	pcs.
PediX Easy 135+65	904678	135 – 200	6 x 160 x 80	15,1	5,0	1,1	4
PediX Easy 200+100	904684	200 – 300	6 x 160 x 80	12,7	5,0	0,75	4

Please note: The stated values are only intended as planning aids. They are subject to typographical and printing errors. Projects must only be calculated by authorised persons.

¹⁾The lateral force resistance must be overlaid with the compressive and tensile load in accordance with ETA-13-/0550 and can therefore lead to lower load-bearing capacities.



25° screw joint for better extension support.



Design-based wood preservation in a carport with PediX Easy.

PediX Duo 150+45 / 190+80

Easy to install thanks to bayonet lock



The PediX Duo 150+45 and PediX Duo 190+80 are post supports for **lightweight timber structures** that meet structural wood preservation requirements. The pedestals' durability is guaranteed by a **zinc/nickel coating**. The post supports can be assembled on the support's end grain without any need for additional joinery work or pilot drilling using fully threaded screws. The bayonet lock permits extremely easy assembly of the top part with the assembled support and the anchored bottom part. The connection is locked by plugging in and pulling up the lock. The connection established in this way can even **transfer tensile forces from the support to the foundation**. Following assembly, the height of the support pedestal can still be adjusted by **45 mm or 80 mm**.

PediX Duo 150+45 / 190+80



Art. no.	Name	Dimensions of baseplate [mm] ^{a)}	Height adjustment in assembled state	PU*
904679	PediX Duo 150+45	160 x 100 x 8	150 – 195	4
904680	PediX Duo 190+80	160 x 100 x 8	190 – 270	4

^{a)}Length x width x height

*Delivery incl. twelve A2 fully threaded screws (Ø 5,0 x 80 mm) per post support.

ADVANTAGES / PROPERTIES

- Simple assembly with fully threaded screws and no need for joinery work, pilot-drilling or milling
- The bayonet lock makes assembling the support pedestal and the structure extremely easy
- Two-part structure
- Min. timber cross section of 100 x 100 mm
- Can be used in the usage classes 1, 2 and 3 in accordance with DIN EN 1995-1-1

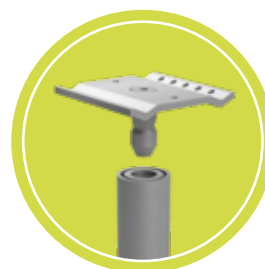

Name	Art. no.	Height adjustment in assembled state	Dimensions of baseplate	Compressive loadbearing capacity	Tensile loadbearing capacity	Lateral force resistance ¹⁾	PU
Post feet on concrete		[mm]	H x L x W [mm]	N _{c,d} [kN]	N _{t,d} [kN]	V _{rk,d} [kN]	pcs.
PediX Duo 150+45	904679	150 – 195	8 x 160 x 100	16,2	9,2	1,1	4
PediX Duo 190+80	904680	190 – 270	8 x 160 x 100	16,2	9,2	0,75	4

Please note: The stated values are only intended as planning aids. They are subject to typographical and printing errors. Projects must only be calculated by authorised persons.

¹⁾The lateral force resistance must be overlaid with the compressive and tensile load in accordance with ETA-13-/0550 and can therefore lead to lower load-bearing capacities.



Height can be adjusted even in mounted condition.



The bayonet lock simplifies the overall assembly of the carport.

H post anchor, Fence post connection screw, Post cap, Hammer-in ground sockets

H post anchor
Hot-dip galvanised steel



Art. no.	Fork width [mm]	Dimensions ^{a)} Overall/Post support [mm]	Drill holes ^{b)} Post support [mm]	PU
Material thickness: 6 mm				
904737	91	600 x 60 / 300	4 x 11	1
904738	101	600 x 60 / 300	4 x 11	1
904739	121	600 x 60 / 300	4 x 11	1
904740	141	600 x 60 / 300	4 x 11	1
Material thickness: 8 mm				
904741	161	800 x 60 / 400	4 x 11	1

^{a)}Length x width / length
^{b)}Number x Ø

ADVANTAGES / PROPERTIES

- For fixing square timber posts in place
- Fixed into concrete using H anchor
- Excellent corrosion protection thanks to hot dip galvanisation



Example of application H post anchor

Fence post connection screw
Specially coated

Suitable for this



Art. no.	Dimensions [mm]	Drive	PU
r903056	8 x 40	TX40 ●	100
r903057	8 x 50	TX40 ●	100
975594	10 x 40	TX40 ●	50
975595	10 x 50	TX40 ●	50

ADVANTAGES / PROPERTIES

- Flange buttonhead screw Ø 8 mm
- Head diameter Ø 22 mm
- Special tip geometry reduces the splitting effect, no pilot drilling required
- No pilot drilling required
- Special protection against corrosion
- Use, for example, in fence and pergola construction

Attention

Not suitable for wood containing tannins!

Fence post connection screw
A2

Suitable for this

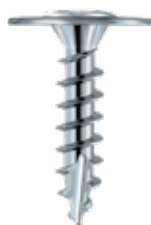

Art. no.	Dimensions [mm]	Drive	PU
975570	8 x 40	TX40 ●	100
975571	8 x 50	TX40 ●	100

ADVANTAGES / PROPERTIES

- Flange buttonhead screw Ø 8 mm
- Head diameter Ø 22 mm
- Special tip geometry reduces the splitting effect, no pilot drilling required
- No pilot drilling required
- Limited resistance to acid

Attention

Not suitable for atmospheres containing chlorine!

Pyramid post cap

Hot-dip galvanised steel



Art. no.	Dimensions [mm]	PU
904733	71 x 71	1
904734	91 x 91	1
904735	101 x 101	1

ADVANTAGES / PROPERTIES

- To protect posts against the effects of weathering
- Visual enhancement thanks to pyramid shape
- Excellent corrosion protection thanks to hot dip galvanisation



Example of application pyramid post cap

Hammer-in ground socket

For square posts



Art. no.	Dimensions Post socket [mm] ^{a)}	Length Spike [mm]	Drill hole Post socket [mm] ^{b)}	PU
904703	150 x 71 x 71	750	4 x 11	1
904704	150 x 91 x 91	750	4 x 11	1
904785	150 x 71 x 71	900	4 x 11	1
904764	150 x 91 x 91	900	4 x 11	1
904730	150 x 101 x 101	900	4 x 11	1

^{a)}Height x length x width

^{b)}Number x Ø

ADVANTAGES / PROPERTIES

- For fixing square timber posts in place
- Socket is fixed into the ground with ground anchors
- Excellent corrosion protection thanks to hot-dip galvanisation



Example of application Hammer-in ground socket for square posts

Hammer-in ground socket

For round posts



Art. no.	Dimensions Post socket [mm] ^{a)}	Length Spike [mm]	Drill hole Post socket [mm] ^{b)}	PU
904705	81 x 150	450	4 x 11	1
904706	101 x 150	450	4 x 11	1
904707	121 x 145	605	4 x 11	1

^{a)}Ø x height,

^{b)}Number x Ø

ADVANTAGES / PROPERTIES

- For fixing round timber posts into place
- Socket is fixed into the ground with ground anchors
- Excellent corrosion protection thanks to hot-dip galvanisation



Example of application for round posts

Screw-on sockets, movable post holders

Hot-dip galvanised steel

Screw-on socket

For square posts



ADVANTAGES / PROPERTIES

- For fixing square timber posts in place
- Socket is fastened to the subsurface with four screws
- Excellent corrosion protection thanks to hot-dip galvanisation

Art. no.	Dimensions Post socket [mm] ^{a)}	Dimensions Baseplate [mm] ^{b)}	Drill holes Baseplate/Post socket ^{c)}	PU
904695	150 x 71 x 71	150 x 150	4 x 11 / 4 x 11	1
904696	150 x 91 x 91	150 x 150	4 x 11 / 4 x 11	1
904697	150 x 101 x 101	150 x 150	4 x 11 / 4 x 11	1
904698	150 x 121 x 121	180 x 180	4 x 11 / 4 x 11	1
904736	150 x 141 x 141	200 x 200	4 x 11 / 4 x 11	1
904743	150 x 161 x 161	240 x 240	4 x 11 / 4 x 11	1
904747	150 x 181 x 181	280 x 280	4 x 11 / 4 x 11	1
904748	150 x 201 x 201	300 x 300	4 x 11 / 4 x 11	1

^{a)}Height x length x width
^{b)}Length x width
^{c)}Number x Ø



Example of application screw-on socket for square posts

Screw-on socket

For round posts

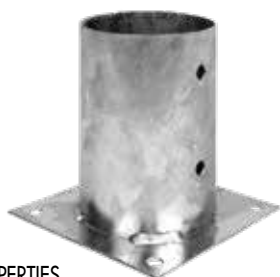

ADVANTAGES / PROPERTIES

- For fixing round timber posts into place
- Socket is fastened to the subsurface with four screws
- Excellent corrosion protection thanks to hot-dip galvanisation

Art. no.	Dimensions Post socket [mm] ^{a)}	Dimensions Baseplate [mm] ^{b)}	Drill holes Baseplate/Post socket ^{c)}	PU
904701	101 x 150	150 x 150	4 x 11 / 4 x 11	1
904702	121 x 147	180 x 180	4 x 11 / 4 x 11	1

^{a)}Ø x height
^{b)}Length x width
^{c)}Number x Ø



Example of application screw-on socket for round posts

Post holder

Movable, for round posts



ADVANTAGES / PROPERTIES

- For fixing round timber posts into place
- Socket is fastened to the subsurface with four screws
- Movable upper section allows attachment to inclined subsurfaces
- Excellent corrosion protection thanks to hot-dip galvanisation

Art. no.	Dimensions Post socket [mm] ^{a)}	Dimensions Baseplate [mm] ^{b)}	Drill holes Baseplate/Post socket ^{c)}	PU
904713	101 x 150	140 x 130	4 x 11 / 3 x 5	1
904714	121 x 150	160 x 150	4 x 11 / 3 x 5	1

^{a)}Ø x height
^{b)}Length x width
^{c)}Number x Ø



Example of application post holder for round posts

U POST HOLDER

Hot-dip galvanised steel

U post holder

Movable, for square posts



ADVANTAGES / PROPERTIES

- For fixing square timber posts in place
- Socket is fastened to the subsurface with four screws
- Movable upper section allows attachment to inclined subsurfaces
- Excellent corrosion protection thanks to hot-dip galvanisation

Art. no.	Fork width [mm]	Length Post support [mm]	Dimensions Baseplate [mm] ^{a)}	Drill holes Baseplate / Post support [mm] ^{b)}	PU
904708	71	100	100 x 100	4 x 11 / 6 x 11	1
904709	91	100	100 x 100	4 x 11 / 6 x 11	1

^{a)}Length x width
^{b)}Number x Ø



Example of application U post holder for square posts

U post holder



ADVANTAGES / PROPERTIES

- For fixing square timber posts in place
- The bracket is fastened to the subsurface with three screws
- Post supports in sides provide spacing between the ground and the timber profile, aiding constructive timber protection
- Excellent corrosion protection thanks to hot-dip galvanisation

Art. no.	Fork width [mm]	Dimensions Post support [mm] ^{a)}	Drill holes Baseplate / Post support [mm] ^{b)}	PU
904717	71	150 x 60	2 x 11 ; 1 x 14 / 6 x 11	1
904719	91	150 x 60	2 x 11 ; 1 x 14 / 6 x 11	1
904721	101	150 x 60	2 x 11 ; 1 x 14 / 6 x 11	1

^{a)}Length x width
^{b)}Number x Ø



Example of application U post holder

U post holder

With stone pin



ADVANTAGES / PROPERTIES

- For fixing square timber posts in place
- The bracket is fixed in the concrete with a 200 mm long stone pin
- Post supports in sides provide spacing between the ground and the timber profile, aiding constructive timber protection
- Excellent corrosion protection thanks to hot-dip galvanisation

Art. no.	Fork width [mm]	Dimensions Post support [mm] ^{a)}	Dimensions Stone pin [mm] ^{b)}	Drill holes Post support [mm] ^{c)}	PU
904716	71	150 x 60	16 x 200	6 x 11	1
904718	91	150 x 60	16 x 200	6 x 11	1
904720	101	150 x 60	16 x 200	6 x 11	1
904715	121	150 x 60	16 x 200	6 x 11	1

^{a)}Length x width
^{b)}Ø x height
^{c)}Number x Ø



Example of application U post holder with stone pin

CORNER CONNECTOR, U BRACKET, POST SUPPORT 135 + 65

Corner connector

For square posts,
Hot-dip galvanised steel



Art. no.	Dimensions Post socket [mm] ^{a)}	Dimensions Baseplate [mm] ^{b)}	Drill holes Baseplate / Post socket [mm] ^{c)}	PU
904710	200 x 105 x 105	82 x 155	2 x 11 / 6 x 11	1

^{a)}Height x length x width
^{b)}Length x width
^{c)}Number x Ø

ADVANTAGES / PROPERTIES

- For fixing square timber posts in place
- The corner connectors are fastened to the base by four screws
- Allow variable width adjustment
- Excellent corrosion protection thanks to hot-dip galvanisation



Example of application corner connector for square posts

U bracket

For fences, Hot-dip galvanised steel



Art. no.	Fork width [mm]	Dimensions [mm] ^{a)}	Drill holes Post support [mm] ^{a)}	PU
904711	101	233 x 40	4 x 6	1
904712	121	270 x 40	4 x 6	1

^{a)}Length x width
^{b)}Number x Ø

ADVANTAGES / PROPERTIES

- For fixing round timber posts into place
- Corrosion protection



Example of application U bracket

Post support 135 + 65

Steel, blue galvanised



Art. no.	Dimensions of baseplate [mm] ^{a)}	PU
904749	6 x 160 x 80	1

^{a)}Height x width x length

ADVANTAGES / PROPERTIES

- Simple assembly with fully threaded screws and no need for joinery work, pilot-drilling or milling
- Min. timber cross section of 100 x 100 mm
- After assembly, height adjustable up to 65 mm
- S235JR (ST37-2) structural steel, blue galvanised
- Can be used in the usage classes 1 and 2 in accordance with DIN EN 1995-1-1



Example of application post support

Name	Art. no.	Height adjustment in assembled state [mm]	Min. post cross section [mm]	Dimensions of baseplate H x L x W [mm]	Compressive loadbearing capacity N _{c,d} [kN]	Tensile loadbearing capacity N _{t,d} [kN]	Lateral force resistance V _{R,d} [kN]	PU
Post feet on concrete		[mm]	[mm]	H x L x W [mm]	N _{c,d} [kN]	N _{t,d} [kN]	V _{R,d} [kN]	Pcs.
Post support 135 + 65	904749	135 – 200	100 x 100	6 x 160 x 80	40,0	6,1	0,8	1



CONDITIONS OF SALE AND DELIVERY

All sales to buyers, customers and contract partners, hereinafter referred to as customers, are made exclusively subject to the following terms and conditions unless other agreements are made in writing in the individual case:

1. SCOPE, GENERAL PROVISIONS

Our terms and conditions shall apply exclusively! We will not accept contradictory terms and conditions of our customers that deviate from our conditions unless we have given our express written consent to their validity. Our terms and conditions shall apply even if we execute orders without reservation despite being aware of contradictory conditions or conditions that deviate from our terms and conditions. Our terms and conditions shall also apply to all future transactions with our customers. Customers can access the latest version of these Standard Terms and Conditions at www.eurotec.team at any time.

2. OFFERS, WRITTEN FORM

Our offers are non-binding and subject to alteration without notice until we issue our final order confirmation. Contracts and agreements, as well as transactions brokered by our representatives, shall become binding only when we issue our written order confirmation. Verbal agreements, even within the framework of contract execution, are not valid unless confirmed by us in writing.

3. PRICES, PACKAGING, OFFSETTING

Unless otherwise indicated by the order confirmation, our prices are ex-works and exclusive of packaging. This is billed separately. The minimum order value is €50.00. For smaller quantities, we charge a flat processing fee of €30.00.

- Our prices are exclusive of statutory value added tax. This is stated and charged separately in the invoice at the statutory rate applicable on the date of billing.
- Our customer may only claim a right of offsetting insofar as counterclaims are established to be legally binding or are undisputed or accepted. A right of retention may only be exercised with respect to counterclaims resulting from the same contractual relationship.

4. DELIVERY, DELIVERY PERIOD AND FORCE MAJEURE

Unless otherwise agreed in writing, the place of performance shall be our company premises. The goods are shipped at the customer's risk and expense by third parties acting on our behalf. From the time at which the goods are made ready for delivery and the customer has been informed of their readiness for shipping, the customer shall bear the risk of accidental loss or deterioration of the item. This shall apply even if shipping is delayed as a result of circumstances for which we are not responsible. Punctual handing over of the goods to a shipping company requires that the order be placed on time by our customer. If the goods are handed over to the appointed shipping company punctually, we will not be liable for delayed delivery to the customer. This shall apply even if a delivery deadline was agreed with the customer, especially in the case of delivery to a construction site. The customer may be exempted from rush charges incurred in relation to this if there is a legal basis for deducting this surcharge from the forwarder's bill.

Statements relating to delivery periods are always to be seen only as approximate and non-binding. They shall begin on the date of our order confirmation but not before all of the order details are clarified in full. They refer to the time of consignment ex-works and shall be considered met when the goods are reported to be ready for dispatch. Without prejudice to our rights arising due to the customer's default, they shall be extended by the period for which the customer is in arrears to us with respect to their obligations arising from this or other orders.

Even if they arise at our suppliers, the following grounds are among those that shall release us from the obligation to adhere to the delivery period and shall entitle us to extend the delivery periods, to make partial deliveries or to wholly or partially withdraw from the part of the contract that is not yet fulfilled without becoming liable to pay damages as a result, unless we are guilty of intent or gross negligence: interruptions of operations and difficulties in delivery of any kind, e. g. shortages of machinery, goods, materials or fuels, or incidents of force majeure, e. g. export and import embargos, fires, strikes, lock-outs or new official measures that adversely affect production costs and shipping.

5. SHIPPING

Goods are shipped at the expense and risk of the customer even if prepaid delivery was agreed. Additional costs for express shipping shall always be borne by the customer. Freight costs paid by us are to be seen only as an advancement of freight charges on behalf of the customer. Additional freight costs for urgent and express parcels shall be borne by the customer, even if we have borne the transport costs on individual occasions. Goods reported as ready for shipping must be accepted immediately and will be charged as exworks. If the goods are to be shipped abroad or passed directly to third parties, they must be examined and accepted in our factory; otherwise, the goods shall be deemed to have been delivered in accordance with the contract to the exclusion of any complaints. The risk, including that of confiscation, shall be transferred to the customer when the goods are handed over to the forwarder or freight carrier and, at the latest, when they leave our facility. Return shipments always require prior consultation with our internal sales department. Goods that are free of defects are only taken back with our express consent. A credit note is then issued for the value of the goods with deduction of a 25 % return fee per item or against a minimum fee of €50 for returning the goods to storage. Strictly no debit notes are accepted.

6. DESIGN AND PROPERTY RIGHTS

The customer shall bear sole responsibility and be liable for ensuring that the goods it orders do not violate third-party property rights. No verification is performed on our part in this respect. The customer shall indemnify us against injunctions or claims for damages by third parties. If an injunction is requested against us, the customer shall meet the legal costs and shall compensate us for the damages we have incurred.

7. ACCEPTANCE, QUANTITY TOLERANCES AND CALL-OFFS

For contracts with ongoing deliveries, the goods are to be accepted in monthly quantities that are as consistent as possible over the course of the contractual period. If a call-off is not made on time, we shall be entitled, after the expiry of a grace period that we have granted, to divide the order at our own discretion, withdraw from the part of the contract that has not yet been executed, or make a claim for damages due to non-performance. In the case of call-off orders, the call-offs must always be made within 12 calendar months. Over- or under-shipment by up to 10 % of the order shall be permissible.

8.1 PAYMENT TERMS FOR INVOICES, RIGHT OF RETENTION

Invoices shall be payable with a 2 % discount within 10 days of the invoice date or net within 30 days, regardless of when the goods are received and without prejudice to the right to make a complaint for defects. Payment by means of acceptance or customer's bill of exchange shall require special written agreement in advance. Discount charges will be charged in the case of payment by means of acceptance, which must have a term no longer than 3 months and be issued within 1 week of the invoice date. Credit notes for bills of exchange or cheques shall apply subject to receipt and regardless of the purchase price's earlier due date in the event of default by the customer. They shall be issued with the value at the date on which the equivalent amount will be available to us; the discount charges will be charged at the respective bank rate. In the event that the payment term is exceeded, interest and commissions

may be charged without prejudice to other rights at the respective bank rate for overdrafts but at a rate at least 5 % above the respective discount rate of the Deutsche Bundesbank [German Federal Bank]. If the payment terms are not adhered to or we become aware of circumstances that, in our view, are sufficient to reduce the customer's credit worthiness, all of our claims shall become payable immediately regardless of the term of any bills of exchange that have been accepted or credited.

We shall then also be entitled to perform outstanding deliveries only in exchange for advance payment, to withdraw from the contract after a reasonable grace period, and to demand compensation for default. We may also prohibit the resale or processing of the delivered goods and demand their return or the transfer of indirect possession of the delivered goods at the customer's expense. The customer hereby already authorises us to enter its premises and confiscate the delivered goods in the above cases. We shall be entitled to the usual securities for our claims according to their nature and extent, even if they are subject to conditions or of limited duration. Offsetting or withholding payments as a result of any counterclaims or notifications of defects shall be prohibited, except where claims are undisputed or established to be legally binding.

8.2 TERMS OF PAYMENT FOR WEB-SHOP CUSTOMERS

Payment shall be made exclusively in advance. Once the order process in our online shop is complete, you will receive an email with the bank details for our business account. The invoiced amount must be transferred to our account within 7 days. We cannot carry out your order until the payment arrives.

9. RETENTION OF TITLE

Until all liabilities arising from the business relationship are paid in full and, in particular, until all bills of exchange and cheques, including finance bills, given as payment are cashed, the goods delivered by us shall remain our property and may be taken back by us at the customer's expense in the event of default in payment. Until this point, the customer shall not be entitled to pledge or assign the goods to third parties as a security; it may sell them on or process them only within the framework of its ongoing business transactions. The customer shall be obliged to inform us immediately of any seizure by third parties of the goods delivered subject to retention of title.

In the event of further processing, the customer shall not acquire ownership of the goods delivered by us as set out in section 950 of the German Civil Code (BGB), as any processing is carried out by the customer on our behalf. Without prejudice to the rights of third-party suppliers, the newly created thing shall serve as security for us up to the amount of our total claims arising from the business relationship. It shall be kept safe for us by the customer and shall be regarded as goods for the purpose of these terms and conditions. If the item is intermixed or otherwise combined with other objects that do not belong to us, we shall acquire at least co-ownership of the new thing in proportion to the value of the contract item to that of other objects that have been processed with it. If the customer sells the goods delivered by us, regardless of their condition, it hereby already assigns to us all claims against its customers arising from sales, as well as all ancillary rights, until all of our claims arising from delivery of goods are paid in full. At our request, the customer shall be obliged to notify its downstream customers of the assignment and to hand over the information and documents we require in order to assert our rights against its downstream customers.

If the total value of the securities given to us exceeds our claims arising from delivery by more than 20 %, we shall be obliged to retransfer securities to this extent at the customer's request. If the retention of title or assignment is invalid in the territory in which the goods are located, a security corresponding to the retention of title or assignment in this territory shall be deemed to be agreed. If the customer's cooperation is required in this process, it shall take all necessary measures to establish such rights.

10. NOTIFICATION OF DEFECTS, LIABILITY

Our customer shall be entitled to a warranty only if they have properly fulfilled their legal obligations under sections 377 and 378 of the German Commercial Code (HGB) with respect to the duties of examination and notification. If defects are present, we shall be entitled at our choice to either repair the defects or provide a replacement; if we are not prepared or not able to do so, and especially if repair/replacement is delayed beyond reasonable deadlines for reasons that we are responsible for, or if repair/replacement otherwise fails, our customer shall be entitled at its choice to withdraw from the contract or to demand a corresponding reduction in the price.

Unless otherwise stipulated below, further claims of the customer shall be excluded regardless of their legal basis.

We shall not be liable for damage that did not occur to the delivered item itself. In particular, we shall not be liable for lost profit or other pecuniary losses of the customer. The above exemption from liability shall not apply if the damage is caused by intent or gross negligence; it shall also not apply if the customer asserts claims for damages for non-performance due to the lack of a warranted characteristic. If we breach an essential contractual duty through negligence, our duty of reimbursement for property damage or personal injury shall be restricted to the level of cover provided by our product liability insurance.

We are prepared to allow the customer to view our policy. The warranty period is 6 months calculated from the date of transfer of risk. This period is a limitation period. The period shall also apply to claims under sections 1 and 4 of the German Product Liability Act (ProdHaftG). Insofar as our liability is excluded or restricted, this shall also apply to the personal liability of our employees, workers, staff, representatives and agents. Goods that are subject to a complaint must not be sent back without obtaining our prior written consent, as otherwise we may refuse to accept them at the sender's expense. Goods that have been partially or wholly processed will not be taken back under any circumstances.

The customer is obliged to make sure that the purchased product is suitable for the intended application using technical descriptions, where available, and based on their specialist knowledge and to familiarise themselves with the application of this product. If they are not familiar with the product's application, our company staff are available to provide advice. All information and advice from our staff is provided carefully and conscientiously.

Under no circumstances does this information and advice replace the indispensable consultancy services of architects and specialist planning companies or the services they provide during construction. Only the authorised professional groups are entitled to provide these services.

11. PLACE OF PERFORMANCE AND JURISDICTION, MISCELLANEOUS

Our company's registered office shall be the place of performance for all obligations arising from this contract, including liabilities from cheques and bills of exchange. Provided our customer is a merchant, the place of jurisdiction for all disputes arising from the contractual relationship shall be, at our choice, the Local Court of Hagen.

Contracts with our customer shall be governed exclusively by German law to the exclusion of the UN Convention on Contracts for the International Sale of Goods of 11 April 1980. The language of the contract shall be German.

Hagen, 16 February 2018

E.u.r.o.Tec GmbH

Unter dem Hofe 5 - 58099 Hagen

Managing directors: Markus Rensburg, Gregor Mamys

Court of registration: Local Court of Hagen Registration number: HRB 3817 VAT ID No.: DE 812674291

Tax number: 321/5770/0639

Tel. +49 2331 62 45-0 · Fax +49 2331 62 45-200 · E-Mail info@eurotec.team · www.eurotec.team



INDEX

12in1 ratchet screwdriver.....	158	EVOdry clip straight.....	69
50X deck screw.....	126	EVOdry closure.....	68
50X long-bit.....	126	EVOdry holder.....	68
50X step drill.....	126	EVOdry rail.....	68
90° EVO joint.....	82	EVO hinge connector.....	84
90° profile connector.....	83	EVO Light aluminium system profile.....	89
180° EVO joint.....	82	EVO Light system clip.....	120
A Adapter.....	54	EVO Light system connector.....	89
Adjustable pedestal BASE.....	31	EVO position anchor.....	82
Adjustable pedestal GIANT.....	50	EVO Slim aluminium system profile.....	87
Adjustable pedestal PRO.....	35	EVO Slim aluminium system profile.....	87
Adjustable pedestal SL BASE.....	33	EVO wall-connection bracket.....	64
Adjustable pedestal SL PRO.....	39	Extension ring GIANT.....	50
Adjustable pedestals PRO CERA.....	46	Extension rings.....	36, 39
Adjustment key GIANT.....	50	F Façadeclip.....	164
Aluminium concrete bracket.....	95	Façadeclip for Rhombus profiles.....	166
Aluminium cover.....	110	Façade fixing screw ZK.....	168
Aluminium eaves.....	111	Fascia profile HKP.....	97
Aluminium function strip.....	100	Fence post connection screw.....	176
Aluminium function strip DiLo.....	100	FLEXI ground anchor.....	42
Aluminium Profile drilling screw.....	78	Flex-Stone-Clip.....	78
Aluminium support-profile connector.....	98	G Gliderscrew.....	122
Angled screwing attachment.....	157	Groove Clip.....	121
B BASE adapter 32.....	31	H Hammer-in ground socket.....	177
BASE adapter 40.....	31	Hapatec.....	141
BASE adapter 60.....	31	Hobotec.....	146
BASE L adapter.....	31	H post anchor.....	176
BiGHTY PH.....	98	I Impate plate Ø 90.....	4
Bit-Box.....	156	L L adapter.....	36, 39
Bit dispenser box with Magnet TX Long Bits.....	156	Load bracket.....	65
Bit dispenser box with TX Long Bits.....	156	Load distribution plate.....	40
Bit holder.....	156	Long bits.....	153
Bits.....	152	Long Bits Set.....	154
C Clickadapter.....	36	M Magnet Bit Set.....	158
Cork pad spacer.....	22	Magnetic Screw Holder.....	155
Cork pad with adhesive tape.....	100	Magnetic socket wrench insert.....	155
Corner connector.....	180	Magnet TX Long Bit.....	158
Corner connectors.....	89	Mammutec.....	148
Cover profile.....	108	MaTre band.....	95
Cross bracing Eveco.....	95	M-Clip.....	121
Cross bracing EVO.....	80	Mini deck glider.....	122
D Deck fascia board mount.....	116	N Nivello 2.0.....	37
Deckglider.....	122	P PediX Duo 150+45 / 190+80.....	175
Decking clip RI4.....	128	PediX Easy 135+65 / 200+100.....	174
Decking multi angles.....	124	Post holder.....	178
DiLo drilling screw.....	100	Post support 135 + 65.....	180
Distance strip 2.0.....	131	Profile connector deck edging set.....	93
Draintec Adapter.....	115	Profile drilling screw.....	132
Draintec Base.....	114	Protectus, timber-protection tape.....	24
Draintec Clip.....	112	Pyramid post cap.....	177
DrainTec – drainage grate.....	112	Q Quattro-Lager.....	54
Drill-Stop.....	161	Quick-change bit holder.....	159
Drill-Stop for Profile drilling screw.....	161		
Drill Tool 50X.....	126		
E Edge finish single support.....	104		
End profiles for aluminium substructure.....	109		
EurotecStone-System.....	76		
Eveco aluminium system profile.....	93		
Eveco corner connector.....	93		
EVO Aluminium system profile.....	62		
EVO aluminium system profile connector.....	64		
EVO corner connector.....	64		
EVOdry clip bent.....	69		



**SIMPLIFIES
YOUR SEARCH**

R	Rolfi roll.....	24
	Rolfi, spacers.....	23
	Roof-protection cork.....	23
	Root control fleece underlay.....	23
S	Screw-on socket.....	178
	Screw Stop.....	161
	Shim.....	52
	Slab support EPDM.....	52
	Slab support PP.....	52
	SL BASE adapter 40.....	33
	SL BASE adapter 60.....	33
	SL BASE-L adapter.....	33
	Snap-in fastener.....	125
	Spacers.....	160
	Stainless steel long Bit.....	157
	StarterClip.....	124
	Stoneadapter.....	36
	Stone-Edge-Clip.....	78
	Stone slab lifter.....	55
	Stone slab spacer.....	55
	Support Clip Set.....	81
	Support-profile HKP.....	97
T	T-beam anchor.....	101
	Tenax spacer.....	160
	Tension clamp.....	160
	TERRA Aluminium System Profiles.....	86-87
	TERRA Centre Panel.....	95
	TERRA Concrete Connector H15.....	94
	TERRA Corner Bracket low.....	92
	TERRA Edge Cover.....	95
	TERRA Fascia Profile H85.....	94
	TERRA Joint 90°.....	93
	TERRA Joint 180°.....	93
	TERRA Multifunctional Corner Connector.....	92
	TERRA Profile Connector H15.....	92
	Terrassotec.....	138
	Terrassotec cylinder head A2.....	135
	Terrassotec ornamental head.....	135
	Terrassotec ornamental head A2.....	134
U	Terrassotec ornamental head A4.....	134
	Terrassotec Trilobular.....	136, 137
	Thermofix screw.....	122
	Tri-Deck-Tec.....	139
	T-Stick.....	127
V	Twin system clip.....	119
	TX-Bit.....	159
	TX Long Bit.....	159
W		
	U bracket.....	180
	Universal Bit-Box.....	157
	U post holder.....	179
	V-Clip.....	129
	Wing-tipped profile drilling screw.....	132



Never miss news again!

Would you like to receive regular information on the latest company activities, career opportunities, innovative new products and product developments? Take a look at **Instagram**, **Facebook**, **YouTube** etc. today and keep up to date anywhere and at any time.

FOLLOW US – WE LOOK FORWARD TO YOUR VISIT!



DID YOU KNOW...?

THE EUROTEC BIM PORTAL IS NOW AVAILABLE!

Many people, including architects, planners, craftspeople and service providers, are involved in the construction of a building or a terrace. All of these people require important data and information to plan their work. In our new Eurotec BIM portal, we provide you with up-to-date BIM-relevant information on our product range.

You will have full access to 3D/CAD data, DWG files, important product information, ETA certifications, and much more. All portal functions are available to you free of charge! The files can be downloaded after a brief registration process.

Follow this link to the BIM portal: bim.eurotec.team



Eurotec®

The specialist for fastening technology

Publisher: E.u.r.o.Tec GmbH - Revised 05/2026
The content is subject to errors and technical changes and additions. All dimensions are approximate values.
The information is subject to model and colour deviations, as well as errors.
We accept no liability for printing errors. Reprinting (even in part) is only permitted with E.u.r.o.Tec GmbH's prior approval.

E.u.r.o.Tec GmbH

Unter dem Hofe 5 · D-58099 Hagen

Tel. +49 2331 62 45-0

Fax +49 2331 62 45-200

E-Mail info@eurotec.team

Follow us



www.eurotec.team